

# BTGF 2025



- HOVEDINDGANG
- TELSTANDE
- UDSTILLINGSBYGNING
- SPISETELT
- MAD OG DRIKKE
- CREW/UDSTILLER MAD OG DRIKKE
- AUKTIONSSEKRETARIATET
- KONTROL
- P-PLADSER
- P VARETRAILER
- MØDESTED
- TOILET
- HANDICAPTOILET
- HJERTESTARTER
- SAMARITTER
- BRANDVEJ
- REDNING KONTAKT PKT
- SKYDEOMRÅDER
- CAMPING



# STANDBYGNING 1 - DEN GAMLE KVIESTALD

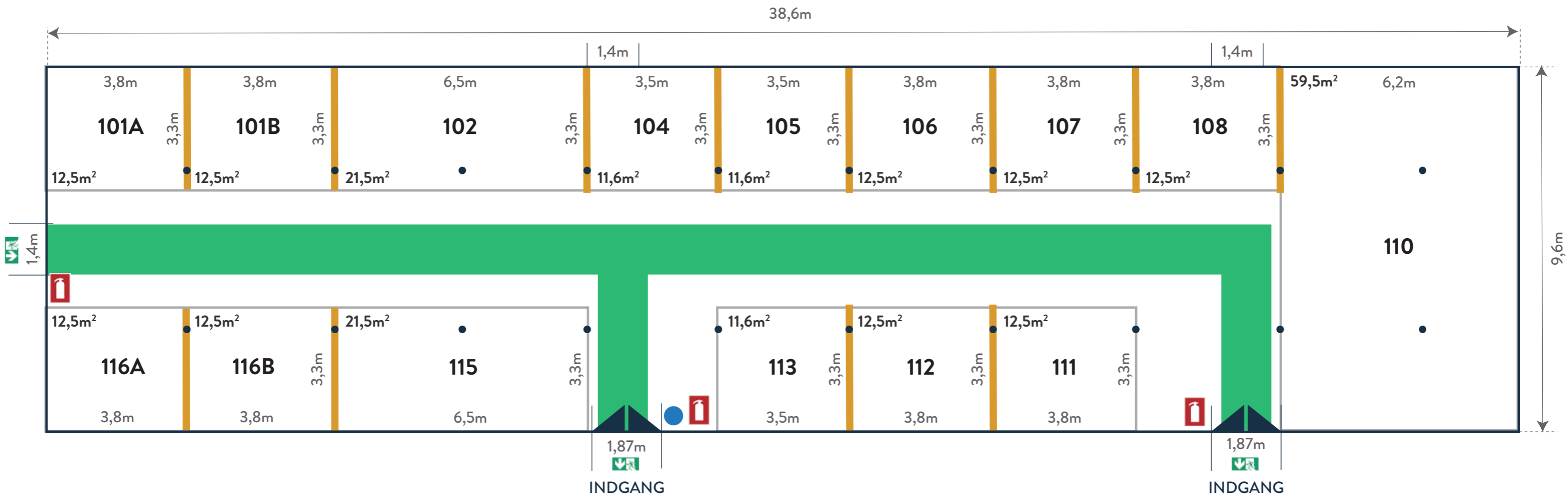

- Opsatte trævægge
- Flugtsareal eller flugtspassage, min 1,3m
- Ophængningssted for beredskabsplan
- Kulsyreslukker
- Flugtsarmatur

Pax	149
Bygning	370,1 m <sup>2</sup>
Stande	237 m <sup>2</sup>

# STANDBYGNING 2 - DEN STORE LADE

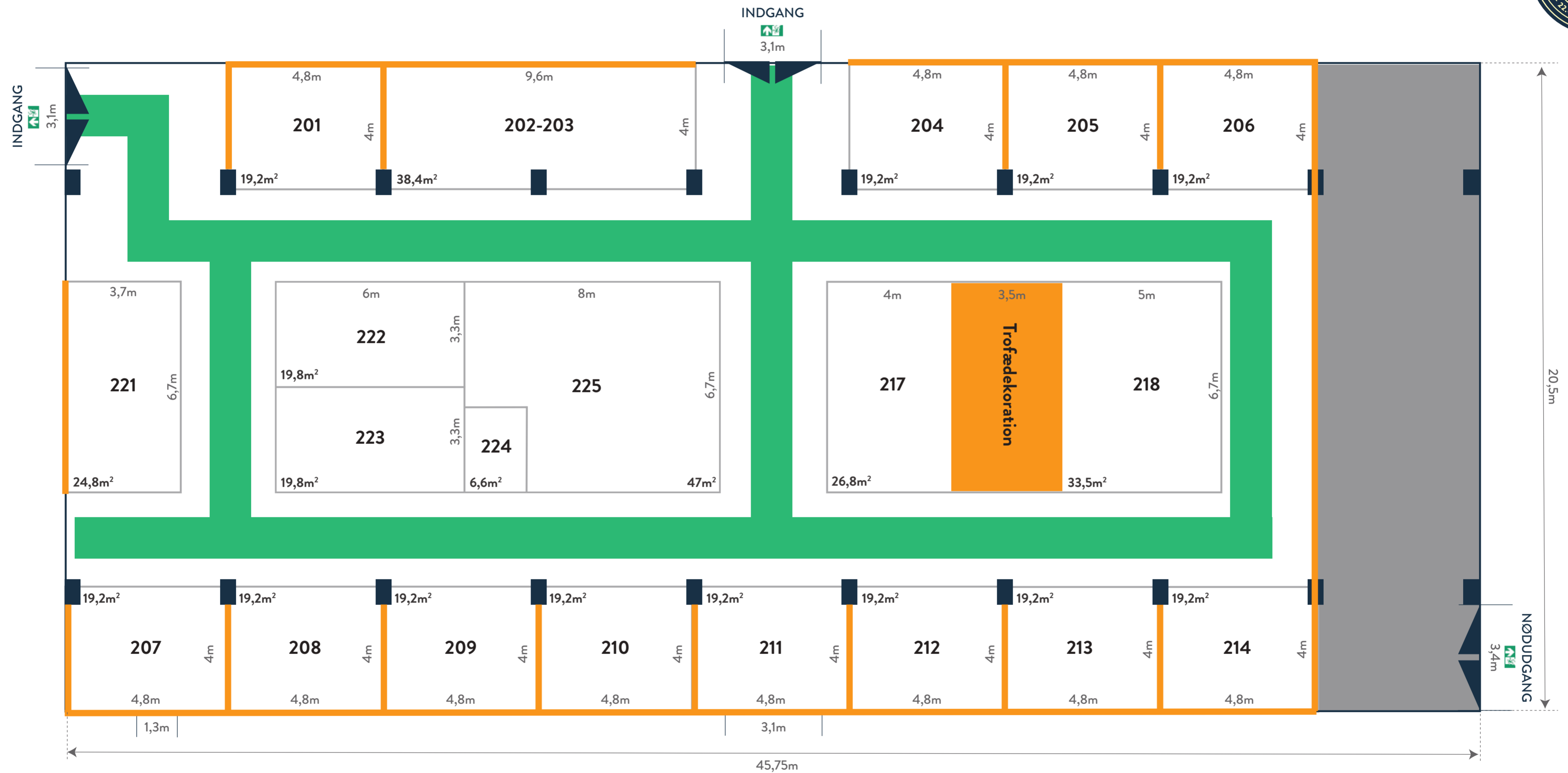





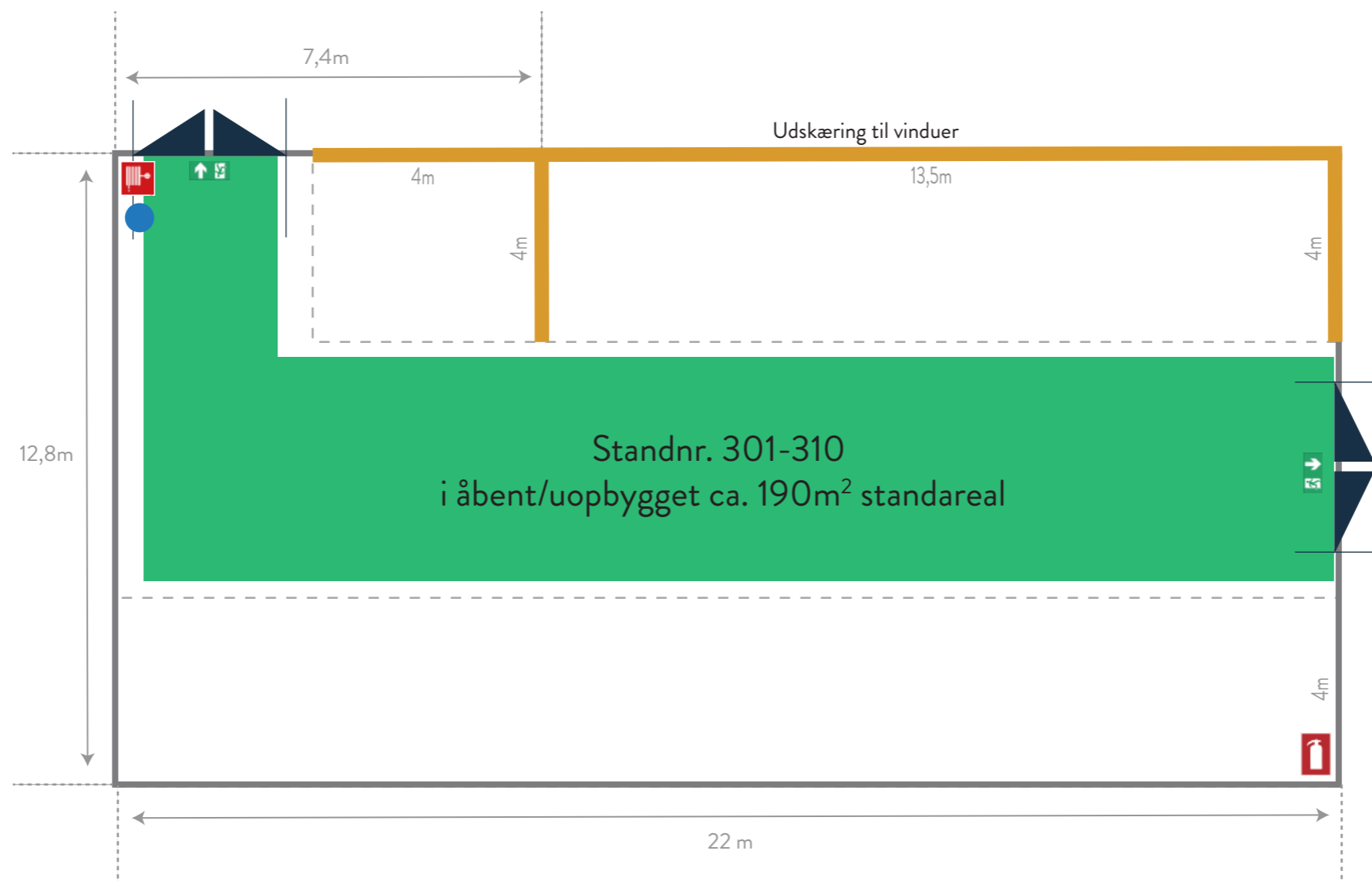

- Opsatte trævægge
- Flugtvejsareal eller flugtvejspassage, min. 1,3m
- Ophængningssted for beredskabsplan
- ⬇ Flugtvejsarmatur

Pax	350
Bygning	813,4 m <sup>2</sup>
Stande, alm	268,8 m <sup>2</sup>
Stande, rå	178,3 m <sup>2</sup>

# STANDBYGNING 3 - DEN LILLE LADE



-  Opsatte trævægge
-  Flugtvejsareal eller flugtvejspassage
-  Ophængningssted for beredskabsplan
-  Kulsyreslukker
-  Slangevinde
-  Flugtvejsarmatur

Pax	?
Bygning	282 m <sup>2</sup>
Stande, alm	? m <sup>2</sup>
Stande, rå	190 m <sup>2</sup>

# STANDBYGNING 4 - DEN GAMLE KOSTALD

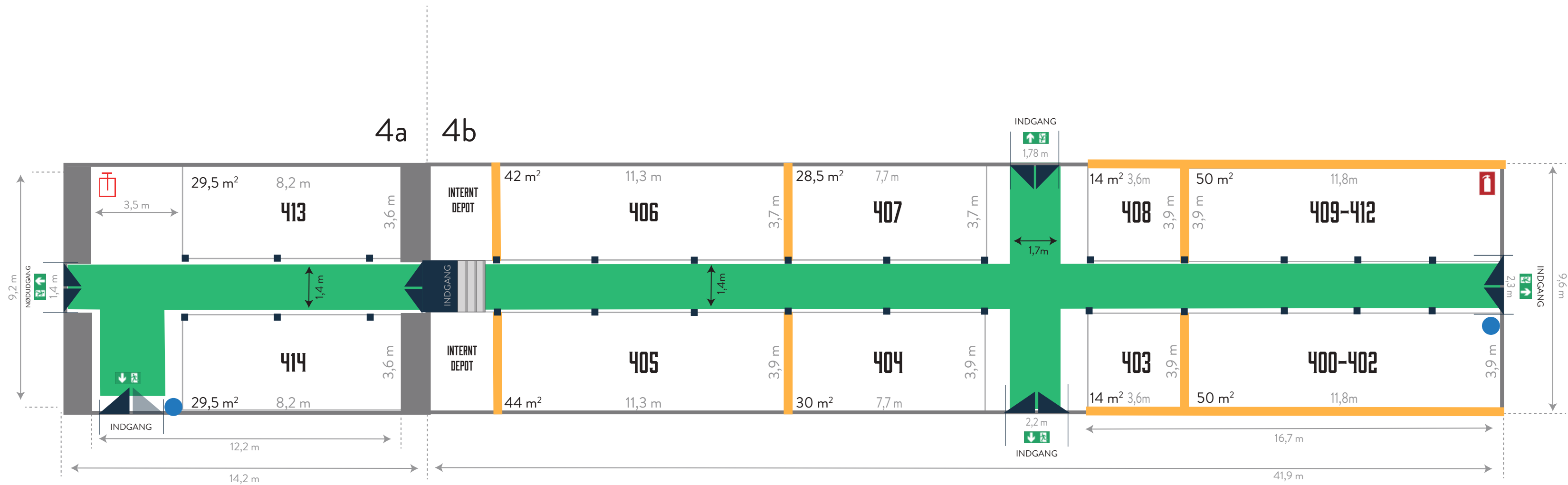

- Opsatte trævægge
- Flugtvejsareal eller flugtvejspassage
- Ophængningssted for beredskabsplan
- Kulsyreslukker
- Håndsprøjtebatteri
- Flugtvejsarmatur

	4a	4b
Pax	149	
Bygning	112,2 m <sup>2</sup>	402 m <sup>2</sup>
Stande, alm	59 m <sup>2</sup>	272,5 m <sup>2</sup>

# STANDBYGNING 5 - DEN NYE LADE

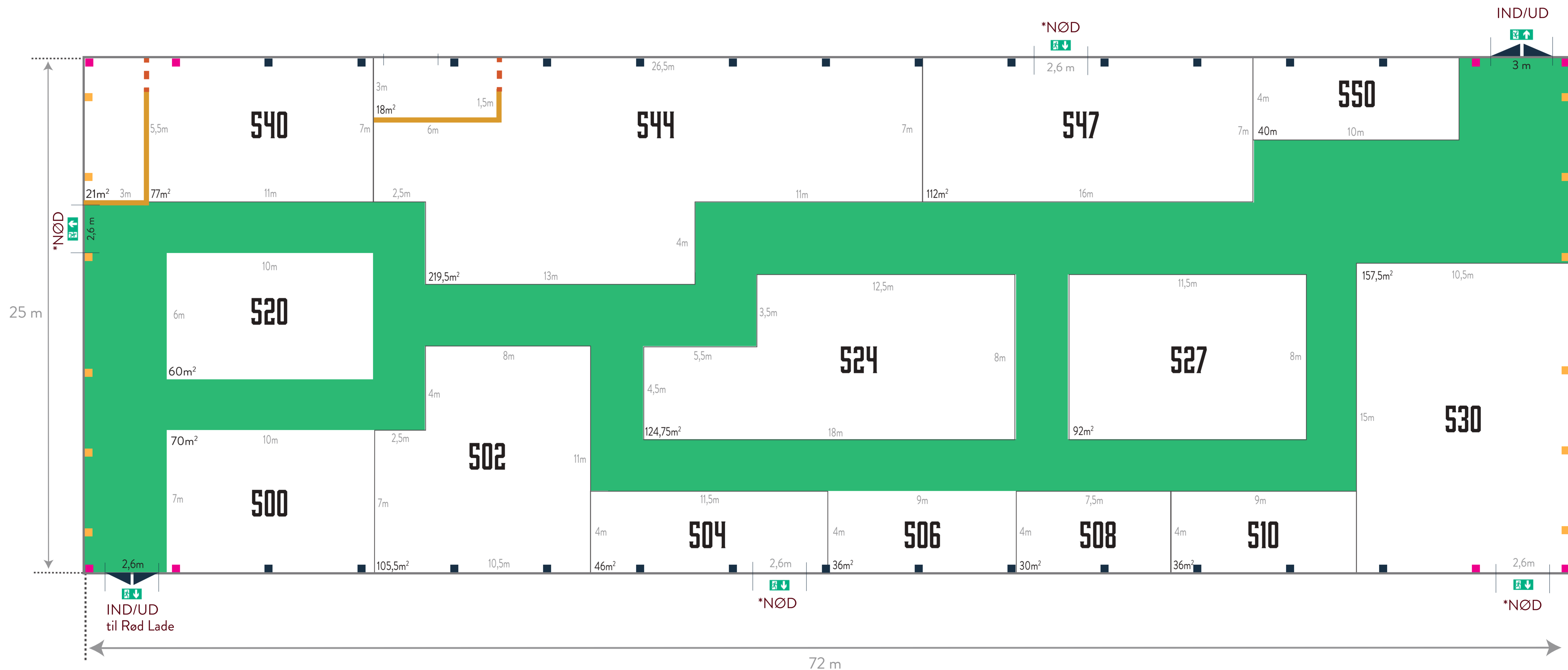

- Forhæng, Bredde: 1,5m
- Eksisterende træbeklædning
- Opsatte trævægge
- Opsætning af trævægge muligt
- Flugtvejsareal eller flugtvejspassage
- Ophængningssted for beredskabsplan
- Kulsyreslukker
- Flugtvejsarmatur

Pax	549
Bygning	1800 m <sup>2</sup>
Stande	1245,25 m <sup>2</sup>

# STANDBYGNING 6 - DEN RØDE LADE

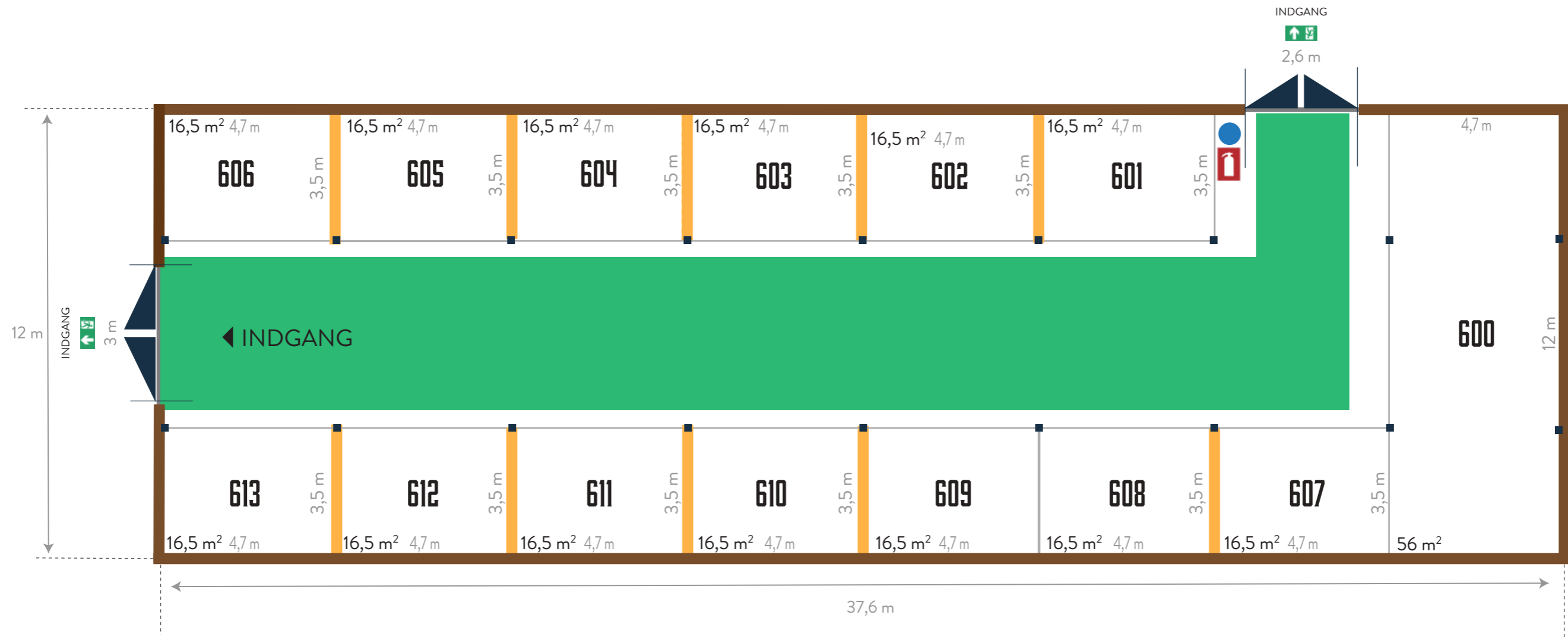

- Eksisterende træbeklædning
- Opsatte trævægge
- Flugtvejsareal eller flugtvejspassage
- Ophængningssted for beredskabsplan
- Kulsyreslukker
- Flugtvejsarmatur

Pax	149
Bygning	451 m <sup>2</sup>
Stande	270,5 m <sup>2</sup>

# TELTE



## Ø ØSTFLØJEN 90 m<sup>2</sup>

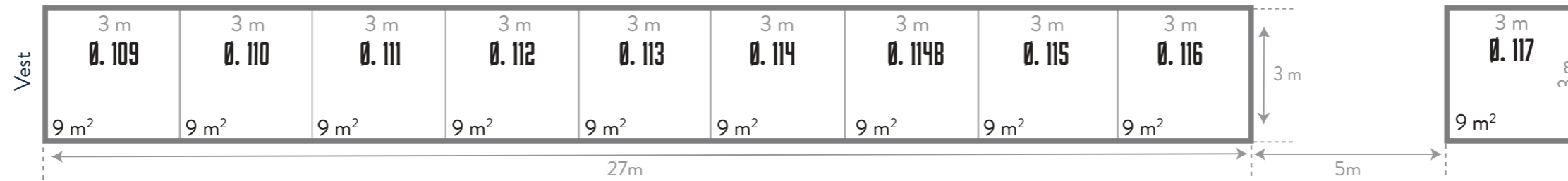

## P1 PARKEN 1 306m<sup>2</sup>

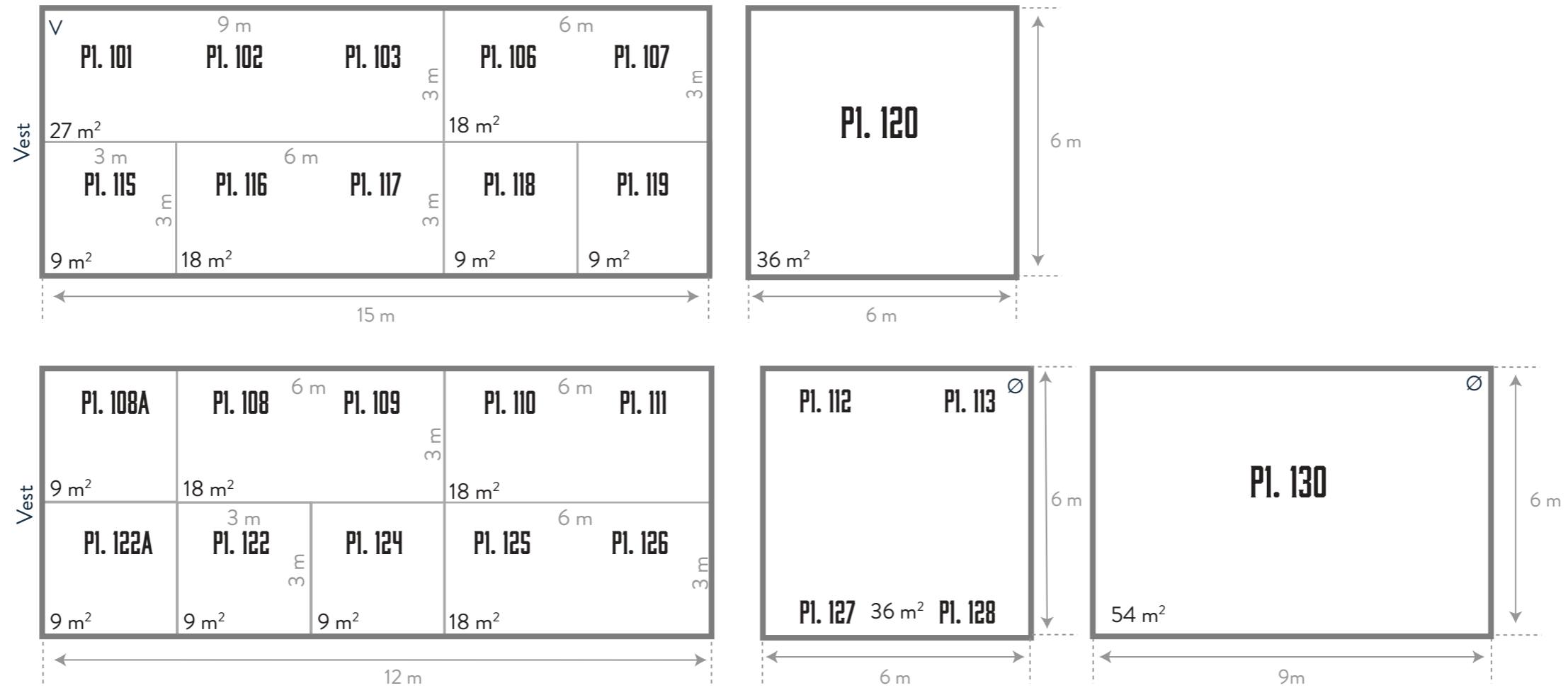



# TELTE



## K KRONDYRHEGNET 108 m<sup>2</sup>

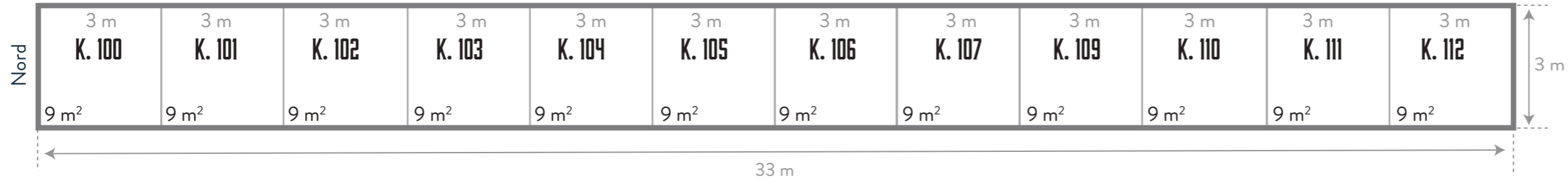

## D DAMMENE 225 m<sup>2</sup>

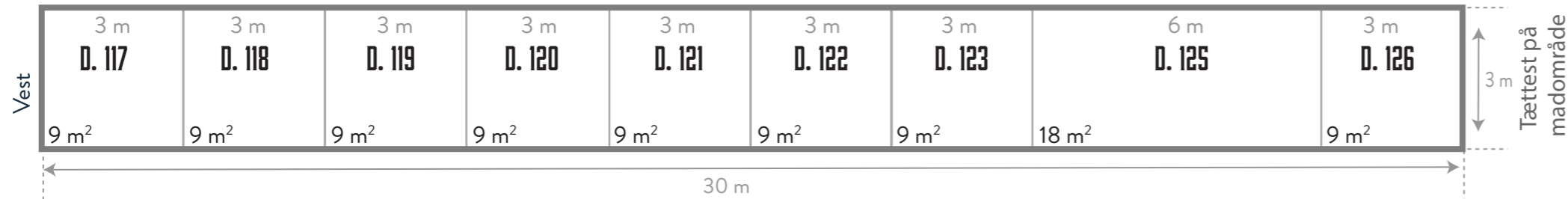
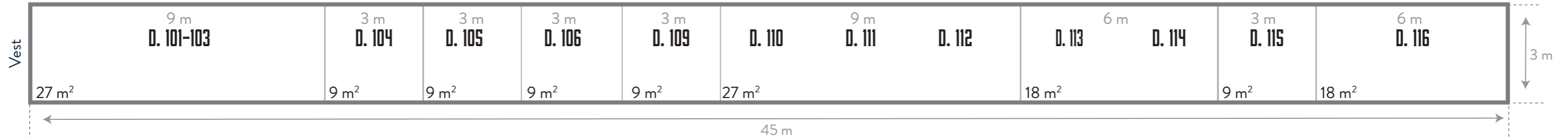

## J KNIVMAGERE 63 m<sup>2</sup> SE DELTAGERE I LISTE VED SIDEN AF



## J KNIVMAGERE





# TELTE

## F FODERHUSET 204 m<sup>2</sup>

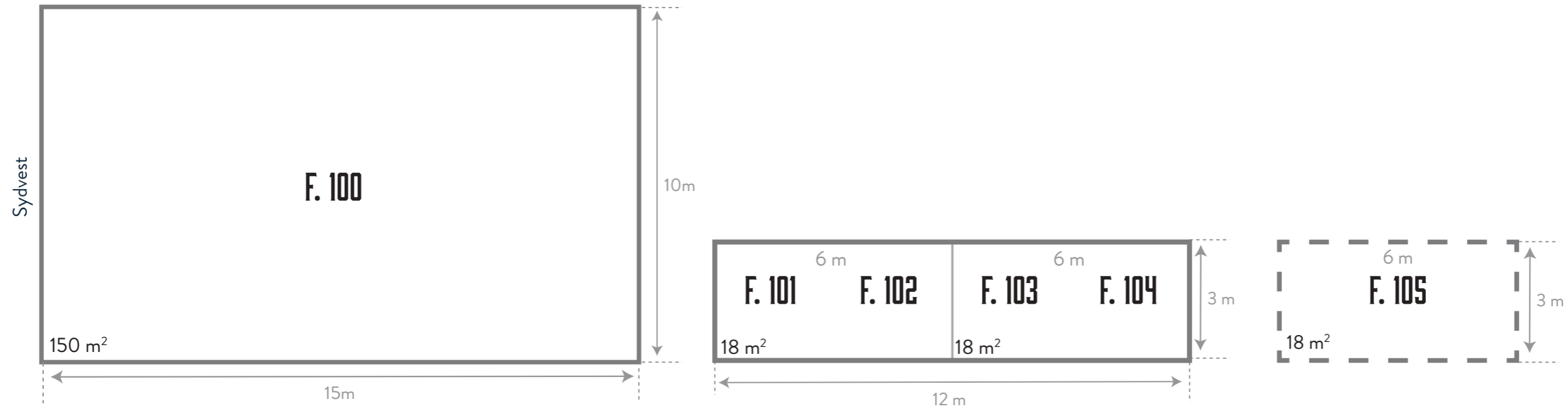

## H HUNDEOMRÅDE V. TRIBUNEN 144 m<sup>2</sup>

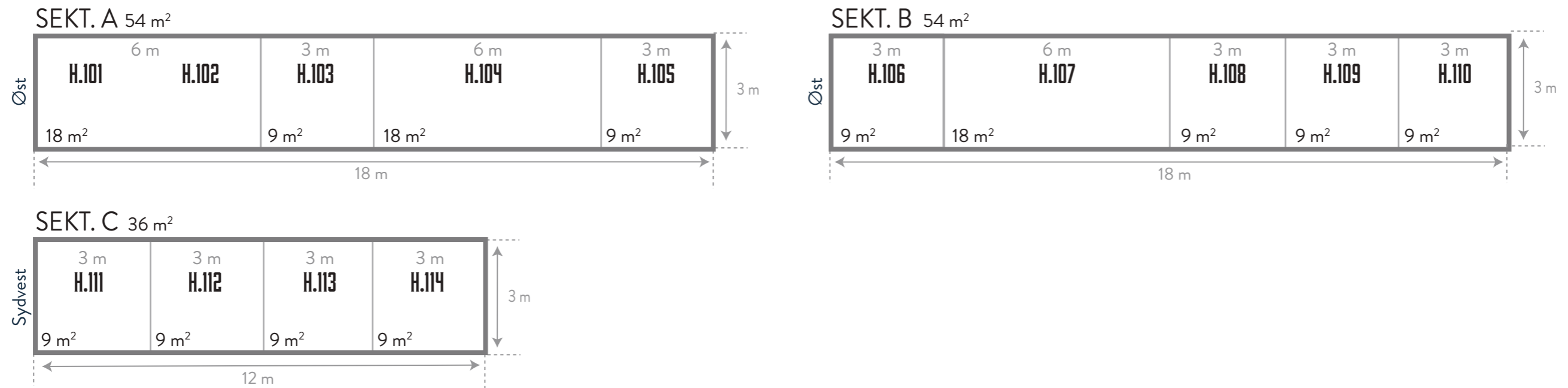

# TELTE



● PLÆNE / PARKEN

● DEMOMARK/4X4 TESTKØRSEL

● SKYDEBANE - HAGL

● SKYDEBANE - RIFFEL/LUFTGEVÆR

● JÆGERFORBUND / BLIV NATURLIGVS / ALLÉEN

● CLINIC BANER

● MADBODER

● OUTDOOR

● GÅRDSPLADS VED BYGNING 6

● VED SKYDEBANERNE