

BTGF 2025



- THE ENTRANCE
- TENT BOOTH
- EXHIBITION BUILDING
- DINNING TENT
- FOOD AND BEVERAGES
- CREW/EXHIBITOR FOOD AND BEVERAGES
- AUKTION OFFICE
- TICKET CHECK
- PARKING
- CARGO TRAILER PARKING
- MEETING POINT
- TOILET
- HANDICAPTOILET
- DEFIBRILLATOR
- SAMARITTER
- FIRE ROAD
- REDNING KONTAKT PKT
- SHOOTING AREA
- CAMPING



EXHIBITION BUILDING 1 - THE SMALL COW STABLE

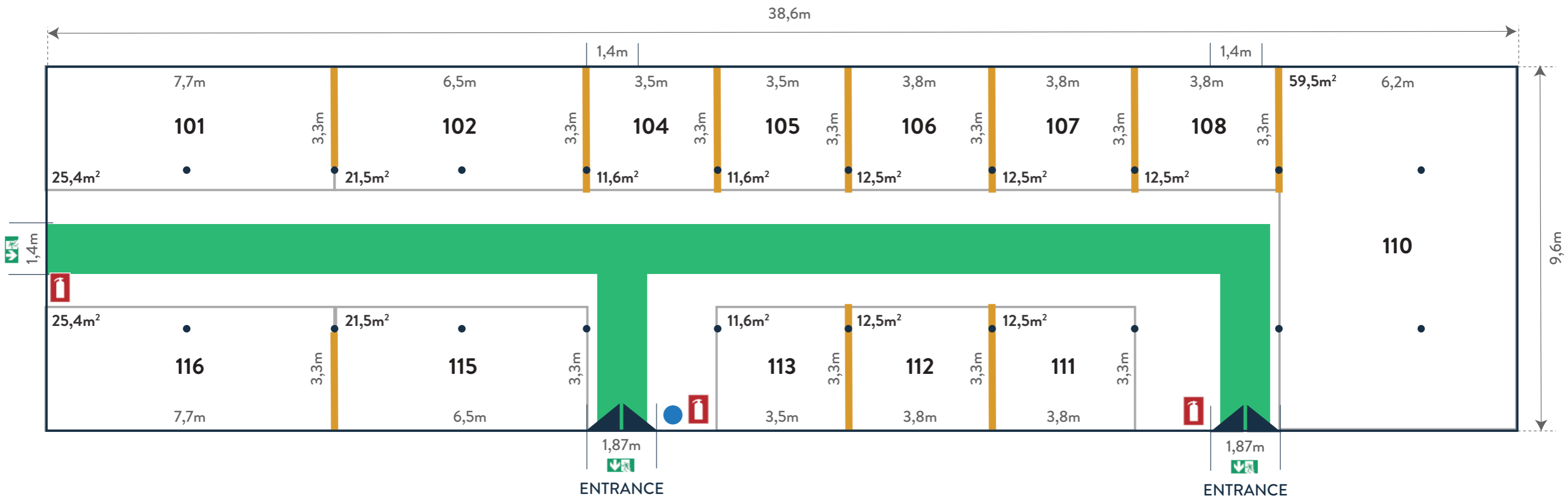

- Wooden walls, installed (could be moved to point ●)
- Escape route
- Escape route
- CO₂ fire extinguisher
- Emergency exit device

Pax	149
Building	370,1 m ²
Build up booth	237 m ²

EXHIBITION BUILDING 2 - THE BIG BARN

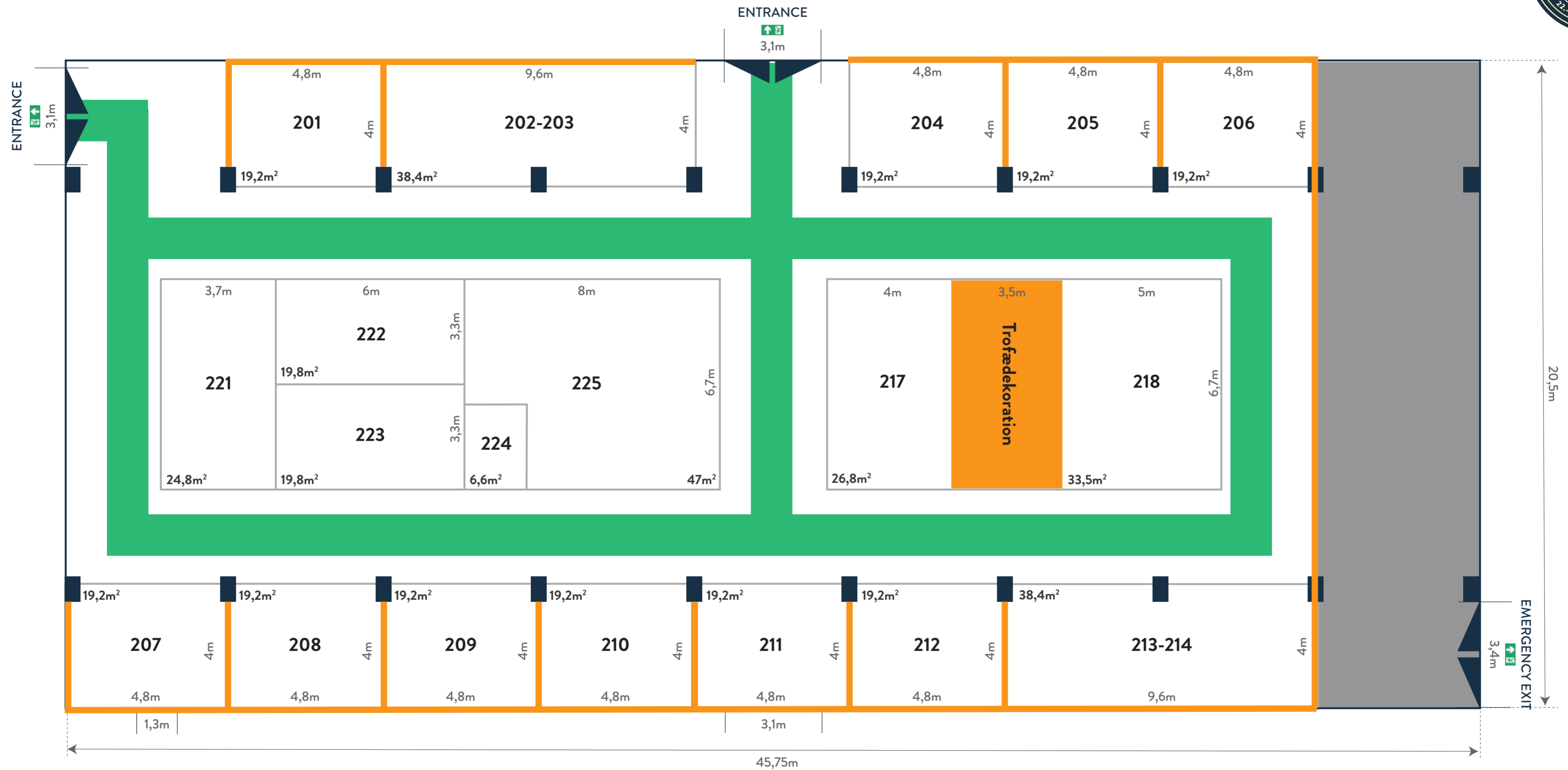

- Wooden walls, installed
- Escape route
- Escape route
- CO₂ fire extinguisher
- Emergency exit device

Pax	350
Building	813,4 m ²
Build-up Booth	268,8 m ²
Raw Booth (middel area)	193 m ²

EXHIBITION BUILDING 3 - THE SMALL BARN

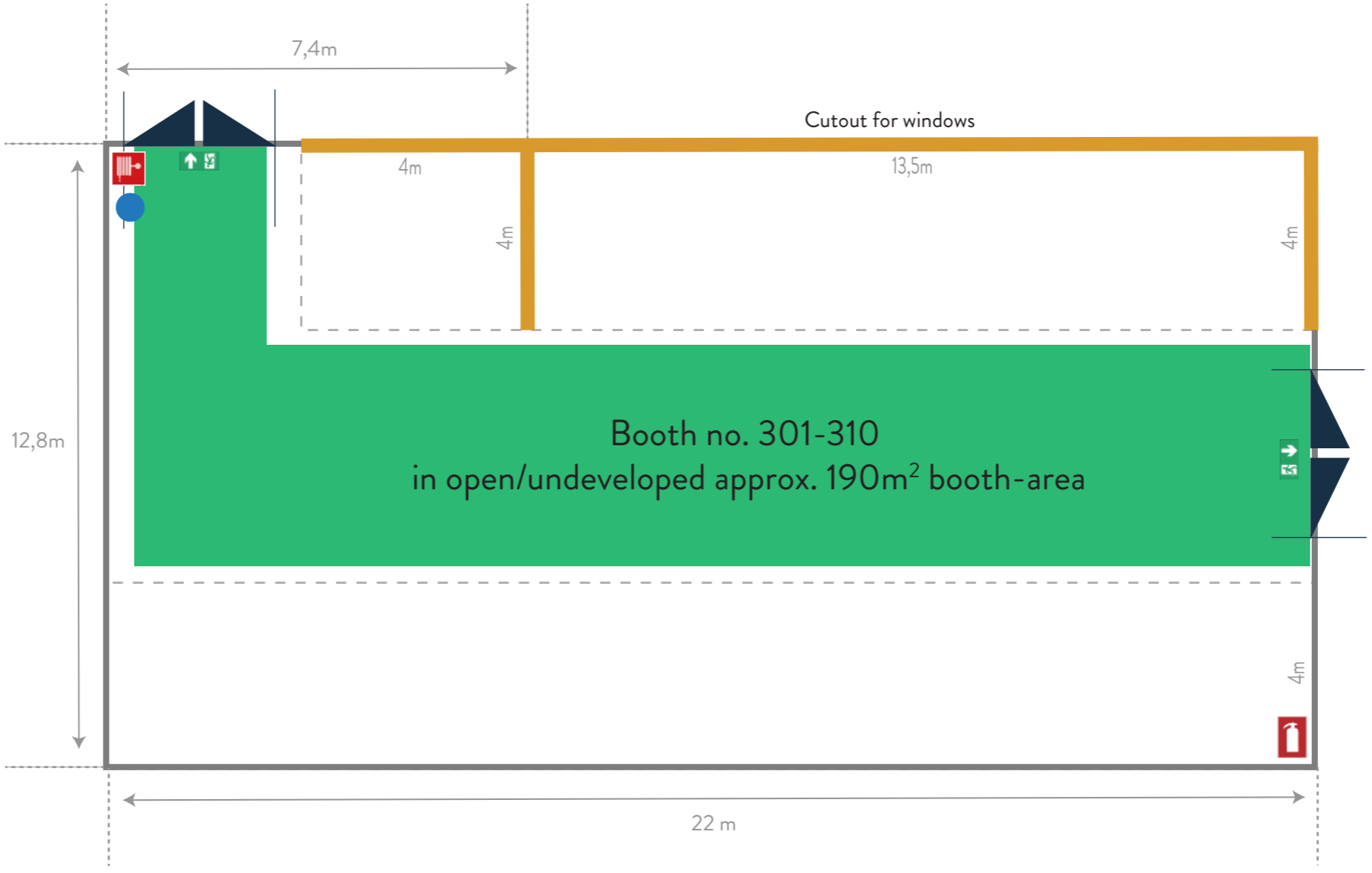





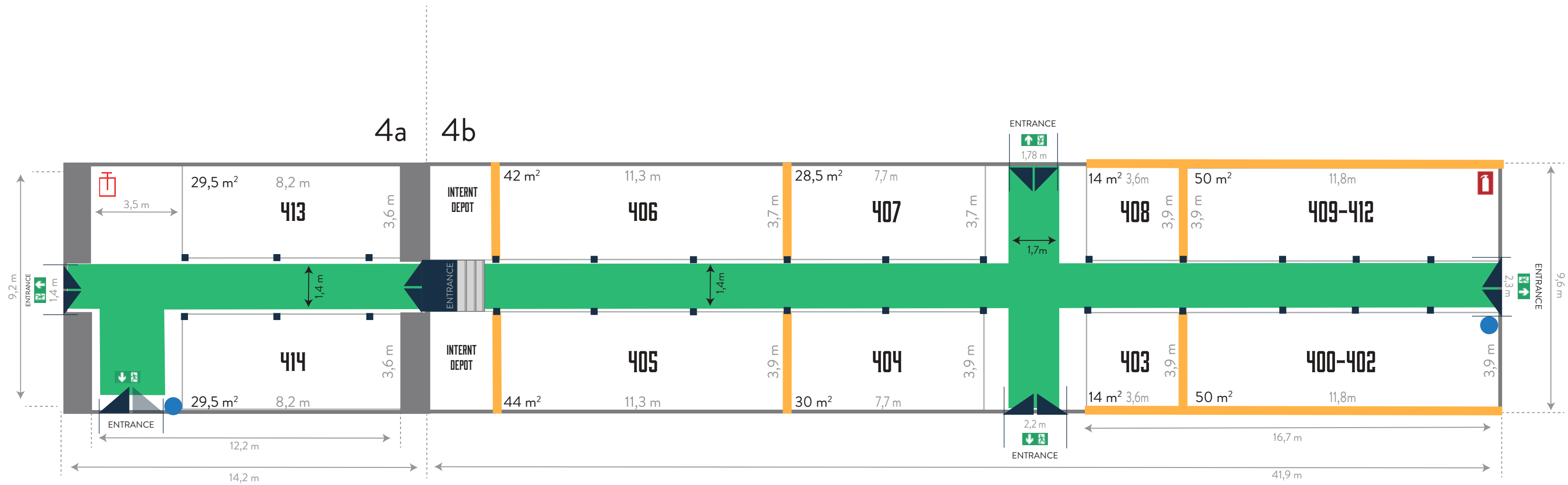

- Wooden walls, installed
- Escape route
- Escape route
- CO₂ fire extinguisher
- Fire hoses reel
- Emergency exit device

Pax	?
Building	282 m ²
Build-up Booth	? m ²
Raw Booth	190 m ²

EXHIBITION BUILDING 4A & 4B - THE OLD COW STABLE







-  Wooden walls, installed
-  Escape route
-  Escape route
-  CO₂ fire extinguisher
-  Hand spray battery
-  Emergency exit device

	4a	4b
Pax	149	
Building	112,2 m ²	402 m ²
Build-up Booth	59 m ²	272,5 m ²

STANDBYGNING 5 - DEN NYE LADE



	Opsatte trævægge
	Flugtvejsareal eller flugtvejspassage
	Ophængningssted for beredskabsplan
	Kulsyre slukker
	Flugtvejsarmatur

Pax	149
Bygning	730 m ²
Stande	340,1 m ²

EXHIBITION BUILDING 6 - THE RED BARN

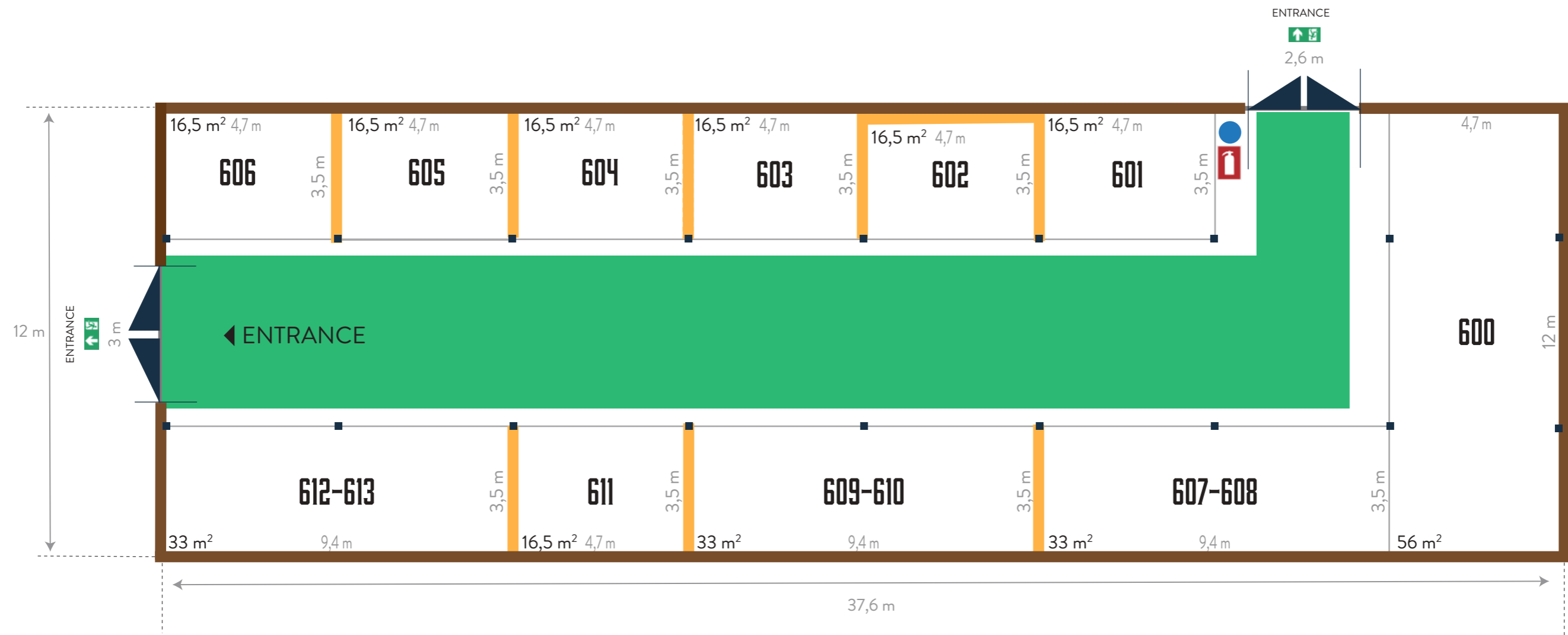

- Existing wood wall
- Wooden walls, installed
- Escape route
- Escape plan
- CO₂ fire extinguisher
- Emergency exit device

Pax	149
Building	451 m ²
Build-up Booth	270,5 m ²

TENTS



Ø THE EATS WING 90 m²



P1 THE PARK 1 216m²

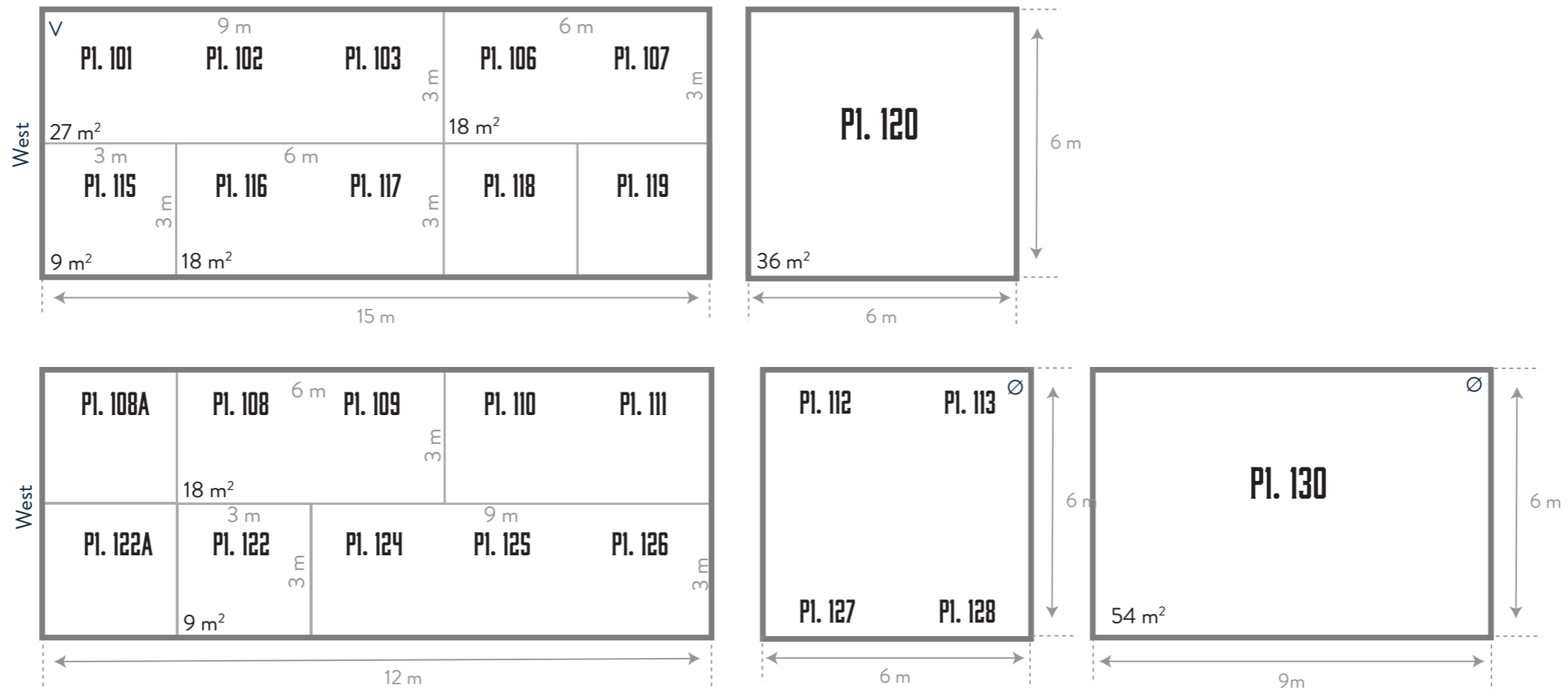



TELTE

K THE RED REED DEER ENCLOSURE 108 m²

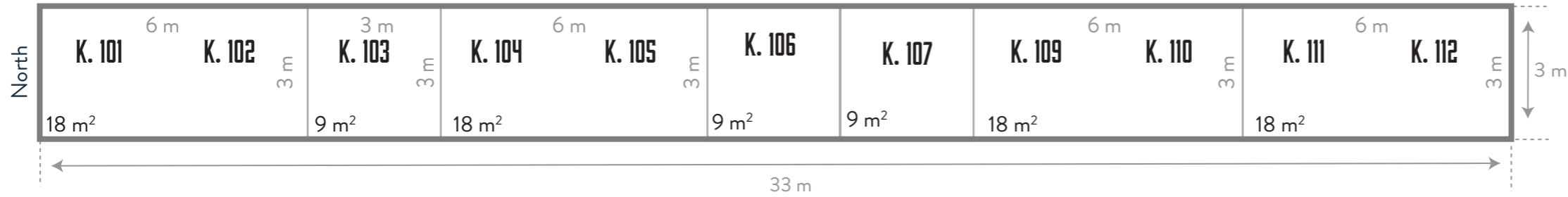

D THE PONDS 243 m²

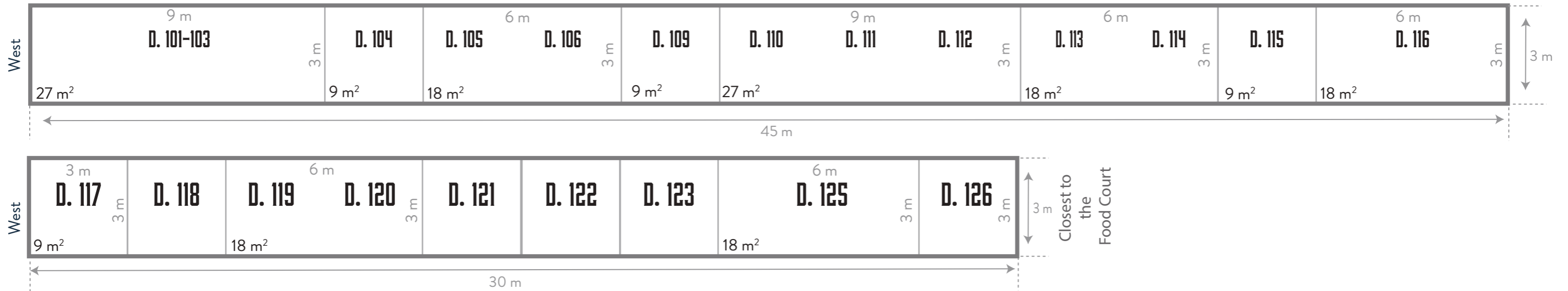

J KNIFE MAKERS 63 m² See the participants in the list J

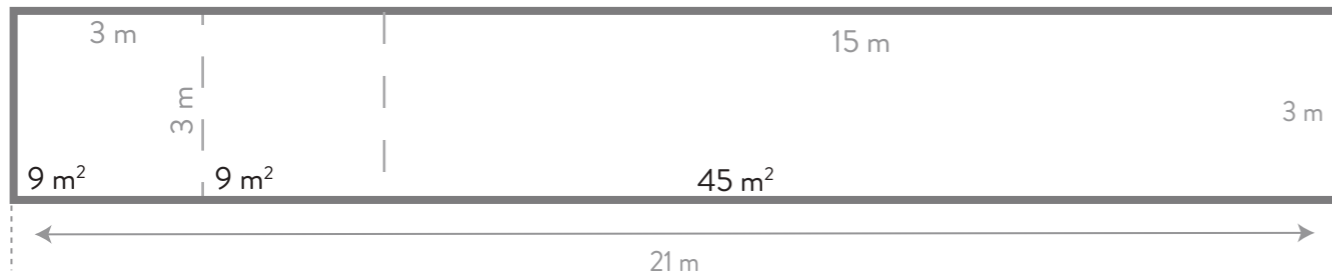

J KNIFE MAKERS



F THE FEEDLOT 36 m²

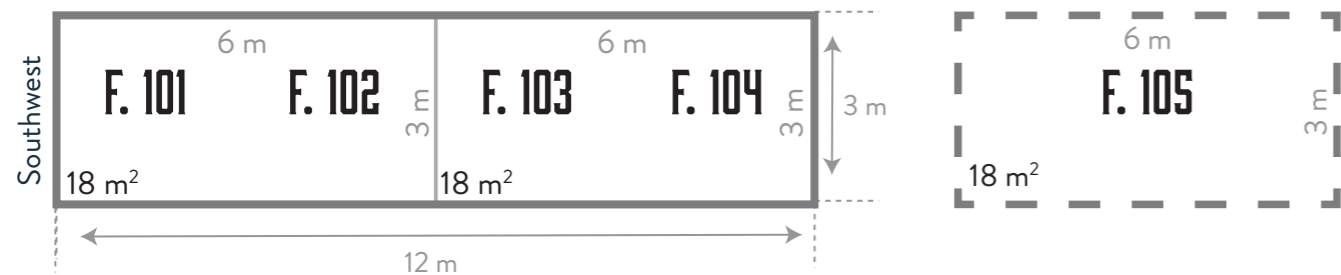

TELTE



H DOGAREA BY THE TRIBUNE 144 m²

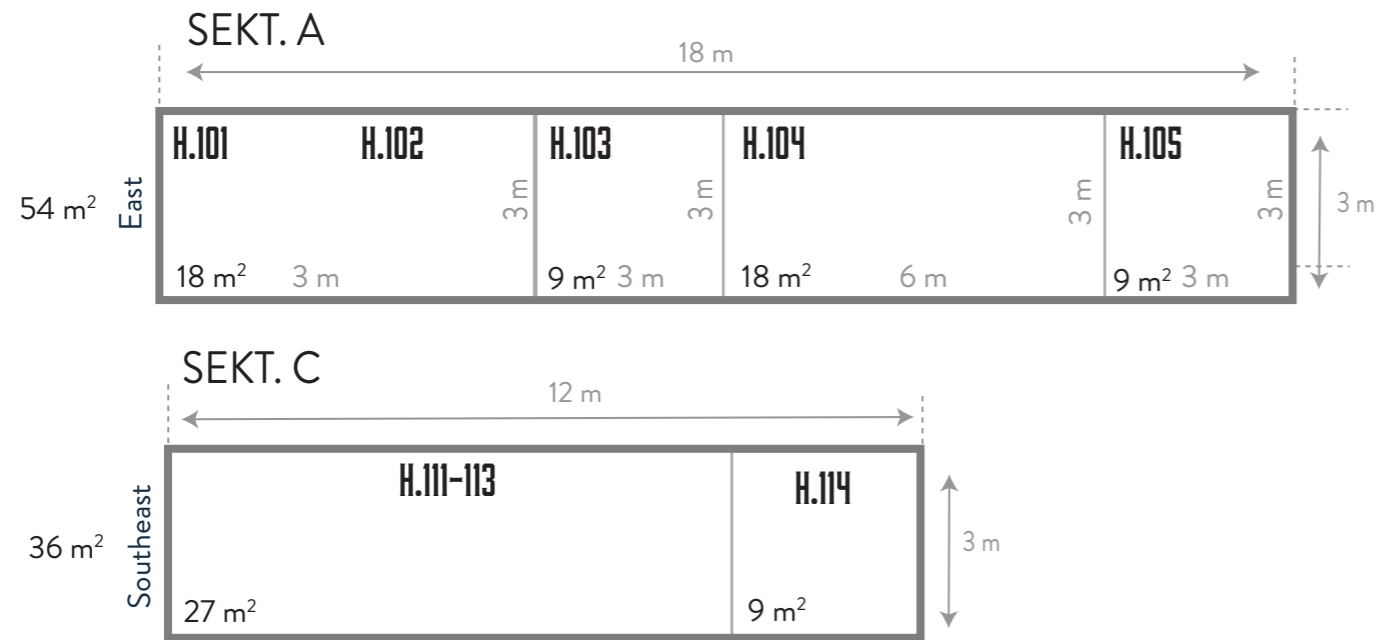

TELTE



● THE PARK

● DEMOFIELD/4X4 TESTDRIVING

● SHOOTINGRANGE - SHOOTGON

● SHOOTINGRANGE - RIFFLE

● JÆGERFORBUND / BLIV NATURLIGVS / ALLÉEN

● CLINIC SHOOTING RANGE

● FOODTRUCKS

● OUTDOOR

● COUNTRYYARD BY BUILDING 6

● BY THE SHOOTING RANGE