

BTGF 2025







- HOVEDINDGANG
- TELSTANDE
- UDSTILLINGSBYGNING
- SPISETELT
- MAD OG DRIKKE
- CREW/UDSTILLER MAD OG DRIKKE
- AUKTIONSSEKRETARIATET
- KONTROL
- P-PLADSER
- P VARETRAILER
- MØDESTED
- TOILET
- HANDICAPTOILET
- HJERTESTARTER
- SAMARITTER
- BRANDVEJ
- REDNING KONTAKT PKT
- SKYDEOMRÅDER
- CAMPING

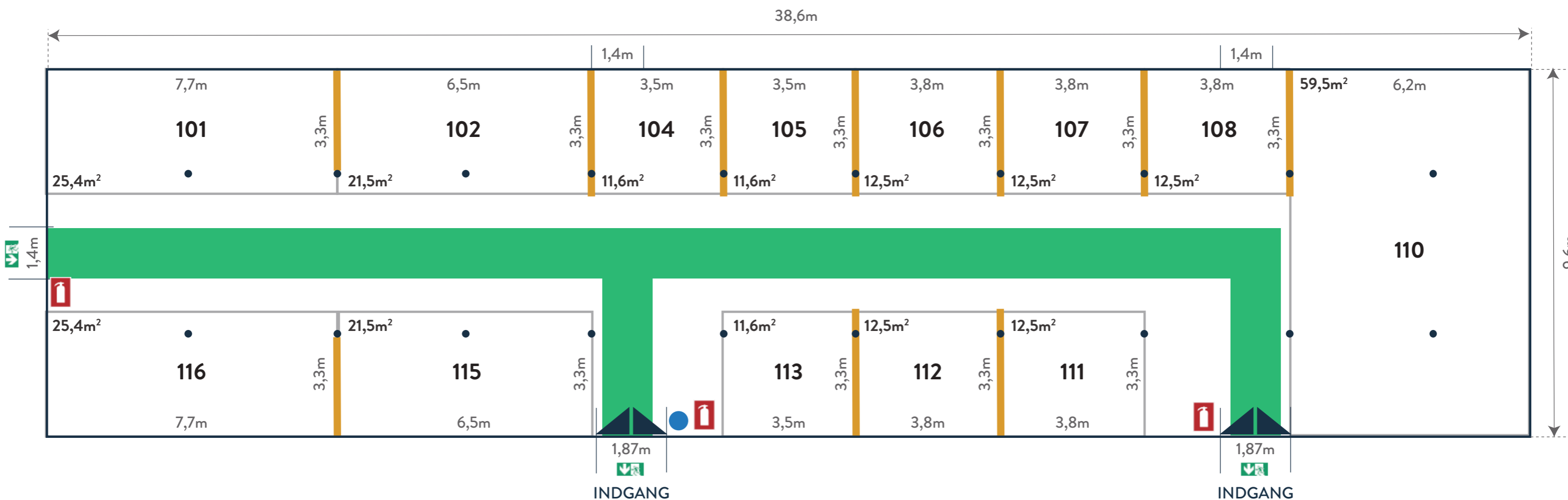

STANDBYGNING 1 - DEN GAMLE KVIESTALD



-  Opsatte trævægge
-  Flugtvejsareal eller flugtvejspassage, min 1,3m
-  Ophængningssted for beredskabsplan
-  Kulsyre-slukker
-  Flugtvejsarmatur

Pax	149
Bygning	370,1 m ²
Stande	237 m ²

STANDBYGNING 2 - DEN STORE LADE

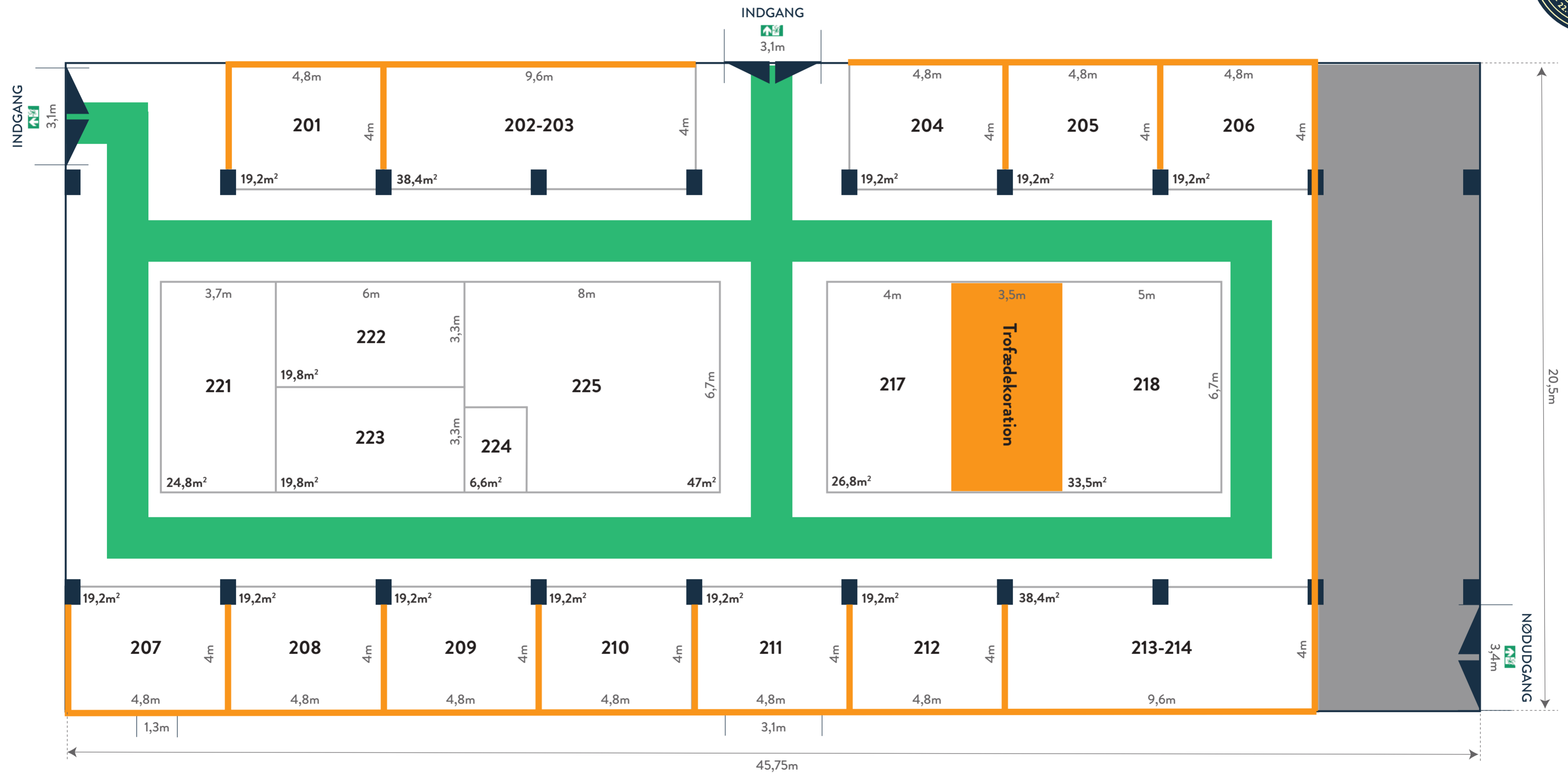

- Opsatte trævægge
- Flugtvejsareal eller flugtvejspassage, min. 1,3m
- Ophængningssted for beredskabsplan
- ⬇ Flugtvejsarmatur

Pax	350
Bygning	813,4 m ²
Stande, alm	268,8 m ²
Stande, rå	193 m ²

STANDBYGNING 3 - DEN LILLE LADE

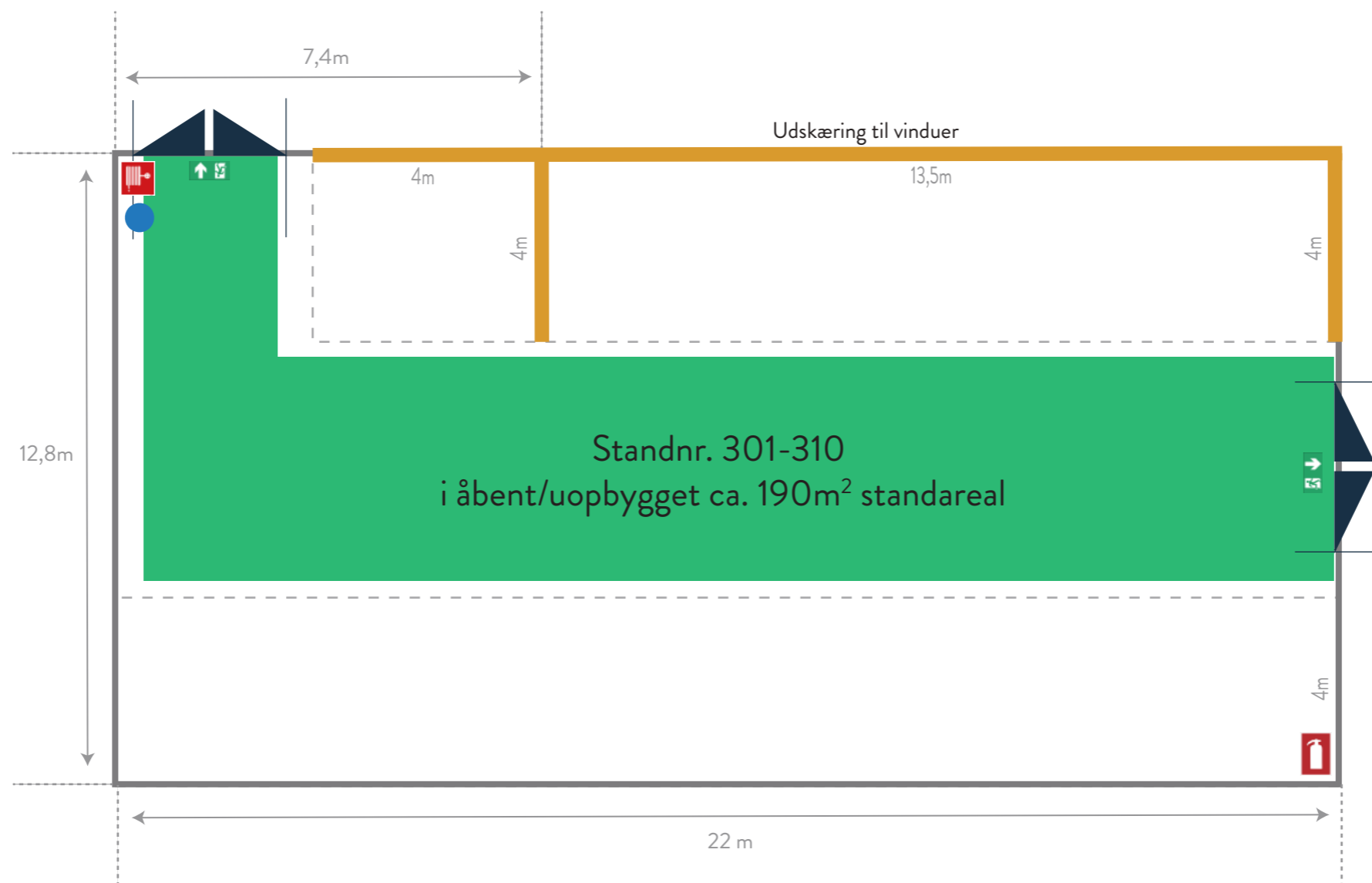

- Opsatte trævægge
- Flugtvejsareal eller flugtvejspassage
- Ophængningssted for beredskabsplan
- Kulsyreslukker
- Slangevinde
- Flugtvejsarmatur

Pax	?
Bygning	282 m ²
Stande, alm	? m ²
Stande, rå	190 m ²

STANDBYGNING 4 - DEN GAMLE KOSTALD

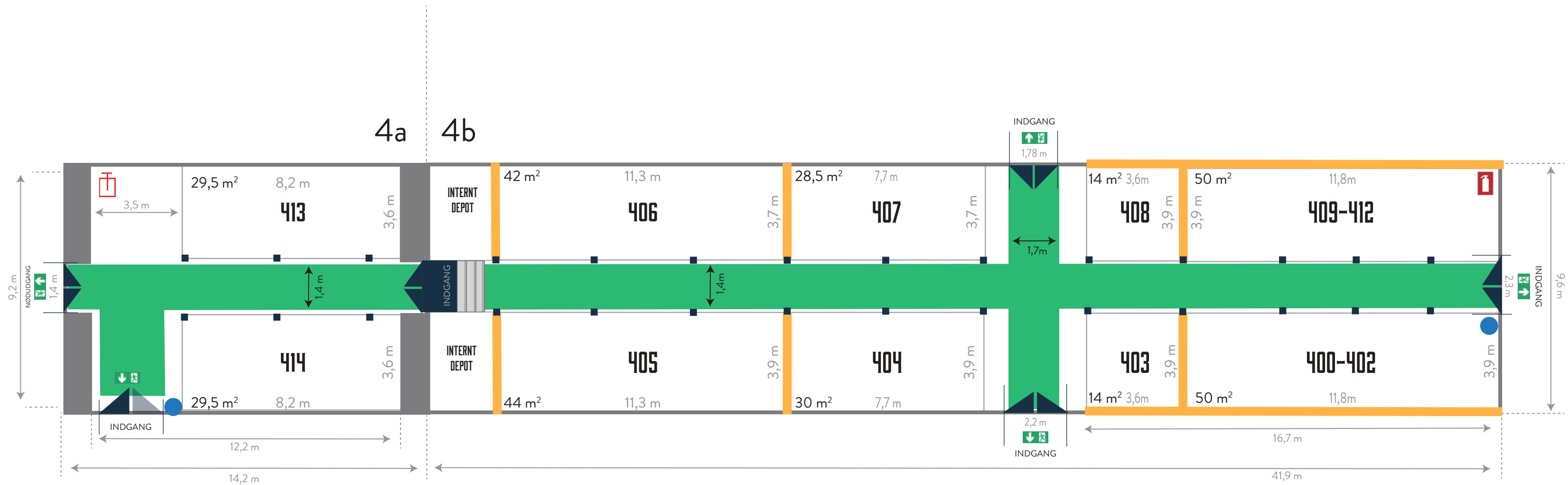





- Opsatte trævægge
- Flugtvejsareal eller flugtvejspassage
- Ophængningssted for beredskabsplan
- Kulsyre-slukker
- Håndsprøjtetænder
- Flugtvejsarmatur

	4a	4b
Pax	149	
Bygning	112,2 m ²	402 m ²
Stande, alm	59 m ²	272,5 m ²

STANDBYGNING 5 - DEN NYE LADE



	Opsatte trævægge
	Flugtvejsareal eller flugtvejspassage
	Ophængningssted for beredskabsplan
	Kulsyreslukker
	Flugtvejsarmatur

Pax	149
Bygning	730 m ²
Stande	340,1 m ²

STANDBYGNING 6 - DEN RØDE LADE

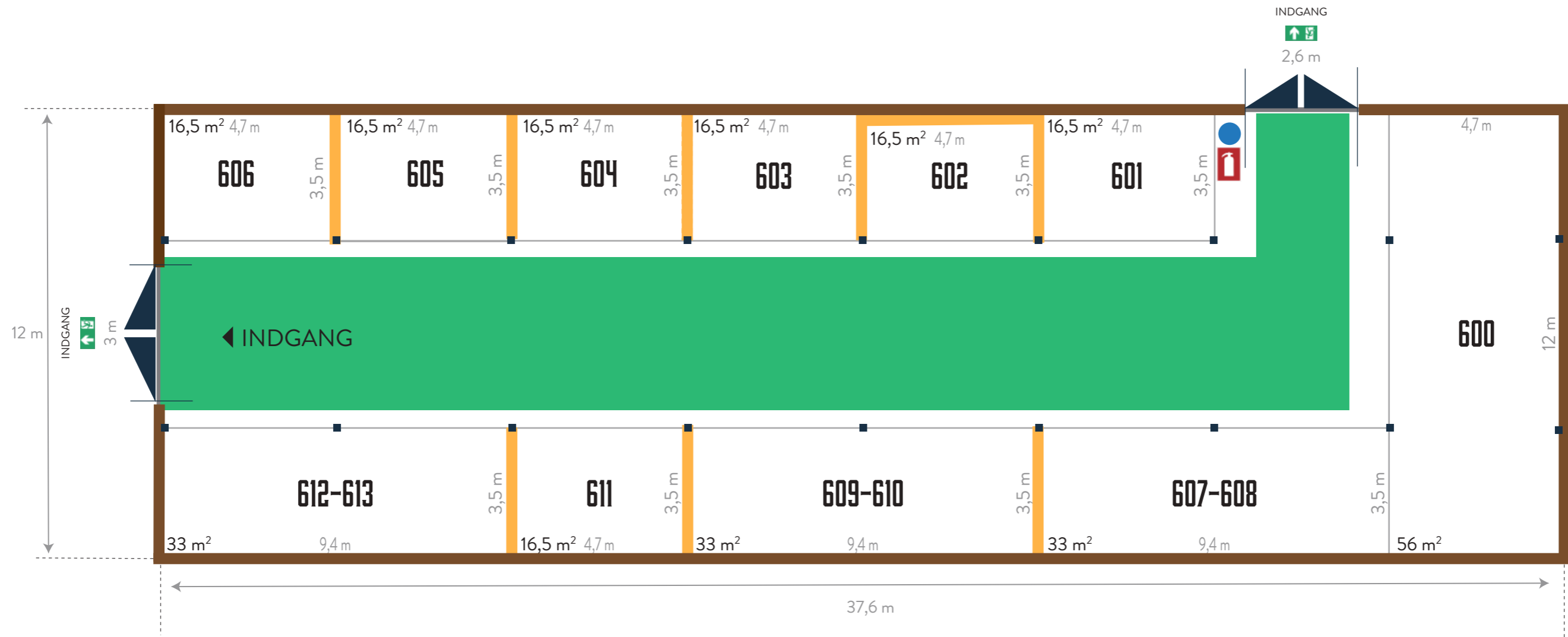

- Eksisterende træbeklædning
- Opsatte trævægge
- Opsætning af trævægge muligt
- Flugtvejsareal eller flugtvejspassage
- Ophængningssted for beredskabsplan
- Kulsyreslukker
- Flugtvejsarmatur

Pax	149
Bygning	451 m ²
Stande	270,5 m ²

TELTE



Ø ØSTFLØJEN 90 m²

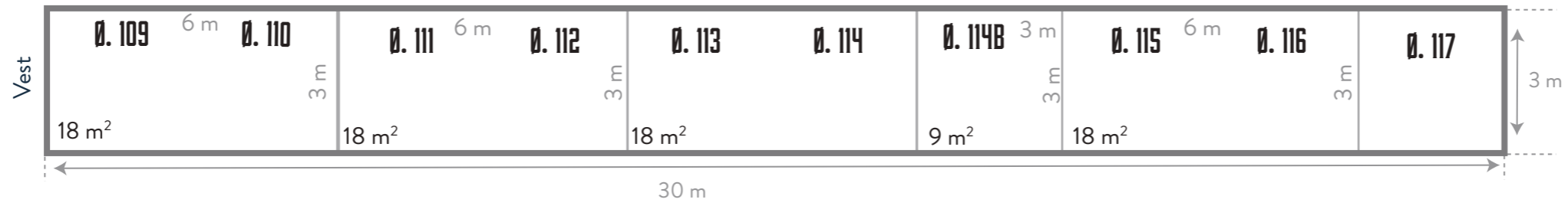

P1 PARKEN 1 216m²

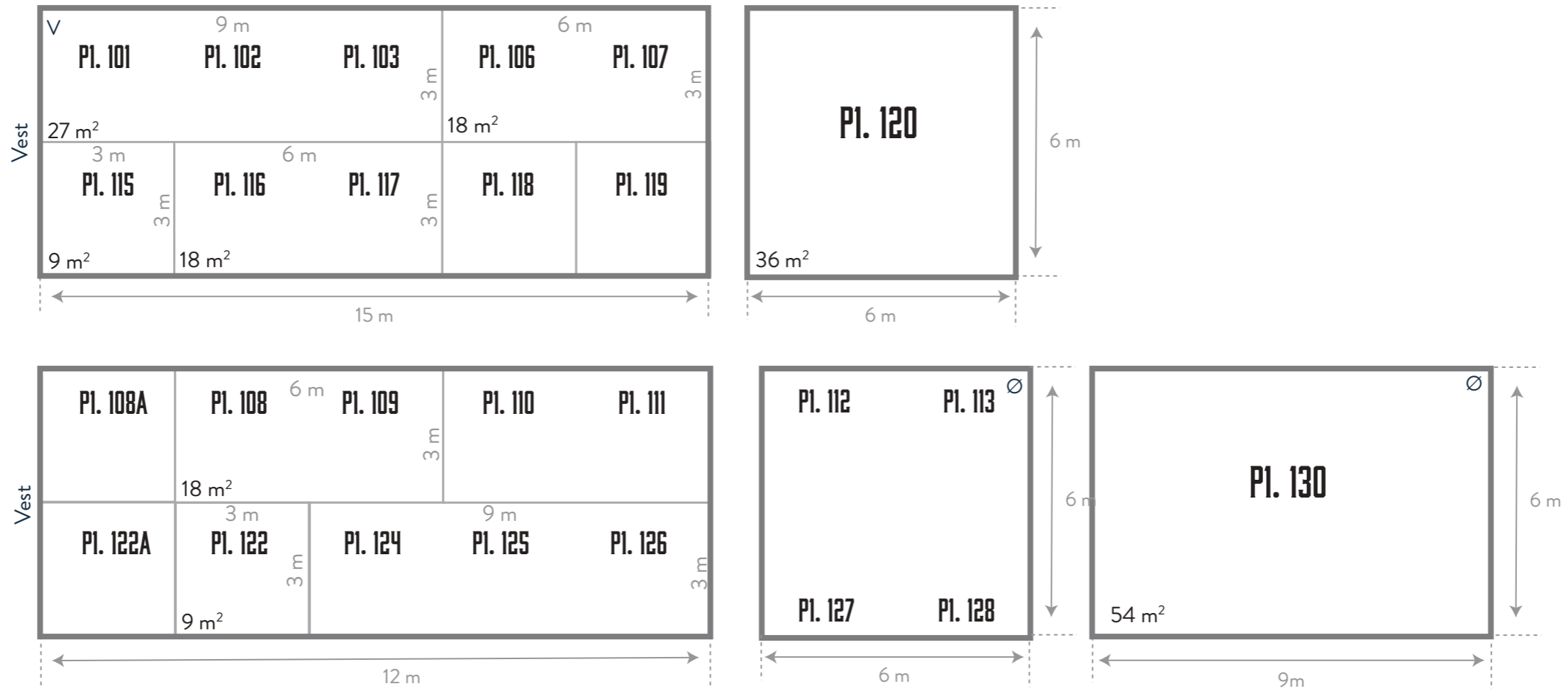



TELTE

K KRONDYRHEGNET 108 m²

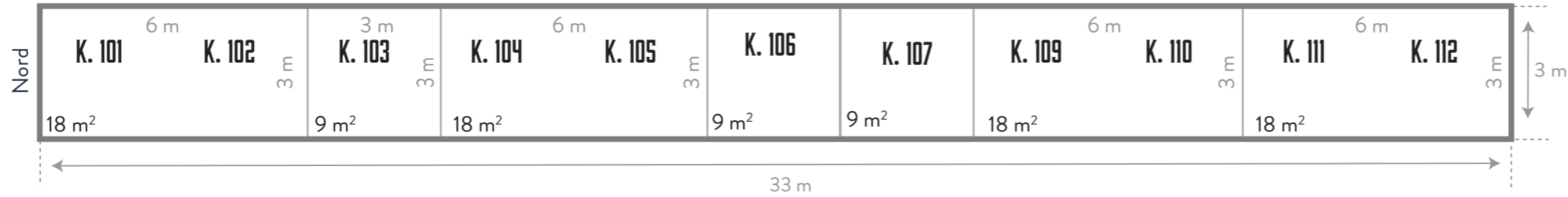

D DAMMENE 243 m²

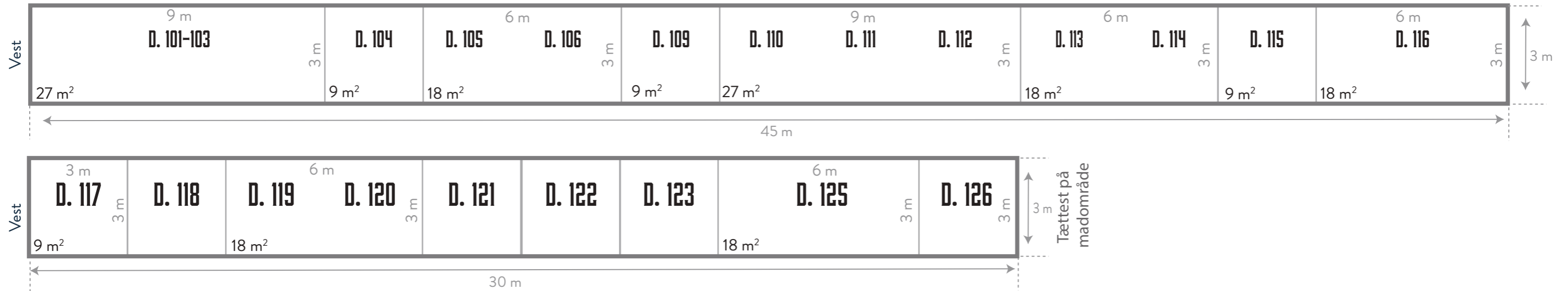

J KNIVMAGERE 63 m² SE DELTAGERE I LISTE VED SIDEN AF

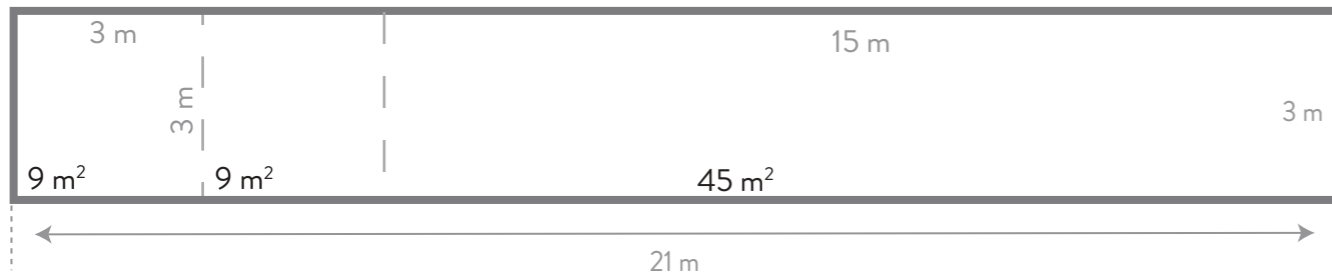

J KNIVMAGERE



F FODERHUSET 36 m²

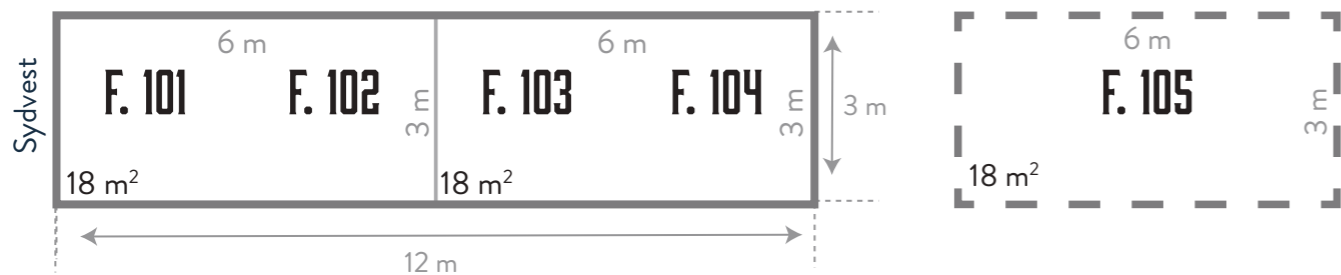

TELTE



H HUNDEOMRÅDE V. TRIBUNEN 144 m²

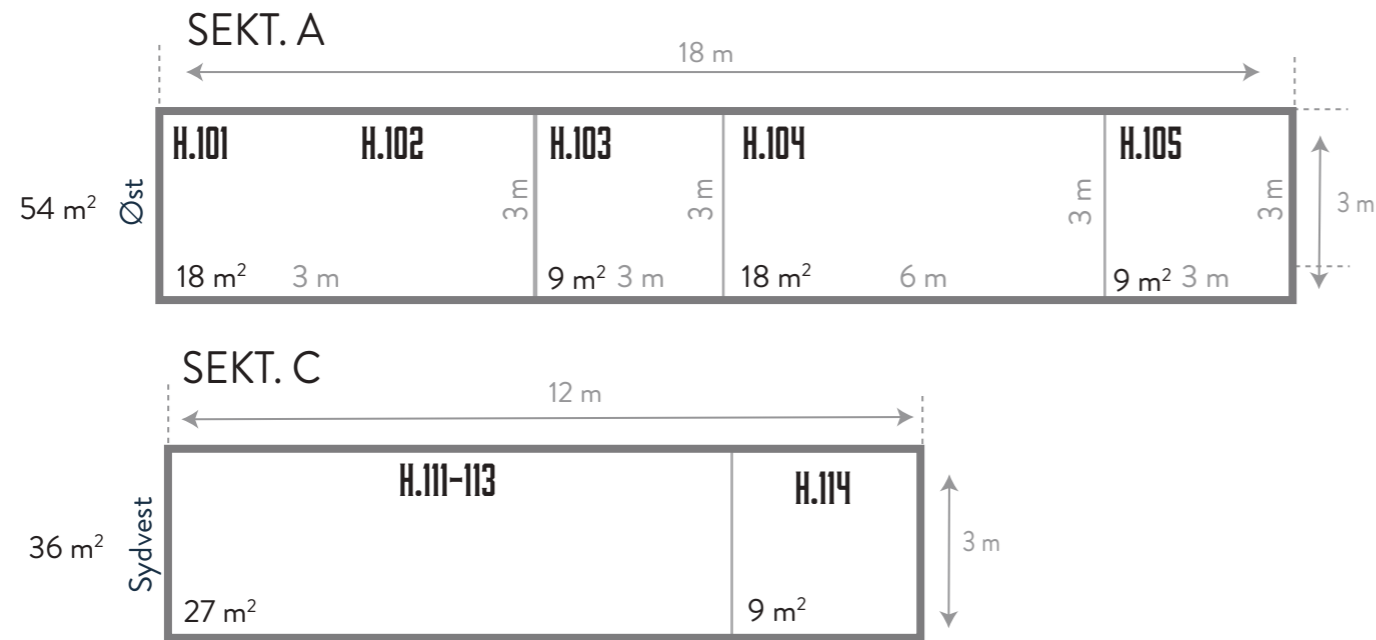

TELTE



● PLÆNE / PARKEN

● DEMOMARK/4X4 TESTKØRSEL

● SKYDEBANE - HAGL

● SKYDEBANE - RIFFEL/LUFTGEVÆR

● JÆGERFORBUND / BLIV NATURLIGVS / ALLÉEN

● CLINIC BANER

● MADBODER

● OUTDOOR

● GÅRDSPLADS VED BYGNING 6

● VED SKYDEBANERNE