

BTGF 2025



- HOVEDINDGANG
- TELSTANDE
- UDSTILLINGSBYGNING
- SPISETELT
- MAD OG DRIKKE
- CREW/UDSTILLER MAD OG DRIKKE
- AUKTIONSSEKRETARIATET
- KONTROL
- P-PLADSER
- P VARETRAILER
- MØDESTED
- TOILET
- HANDICAPTOILET
- HJERTESTARTER
- SAMARITTER
- BRANDVEJ
- REDNING KONTAKT PKT
- SKYDEOMRÅDER
- CAMPING



STANDBYGNING 1 - DEN GAMLE KVIESTALD

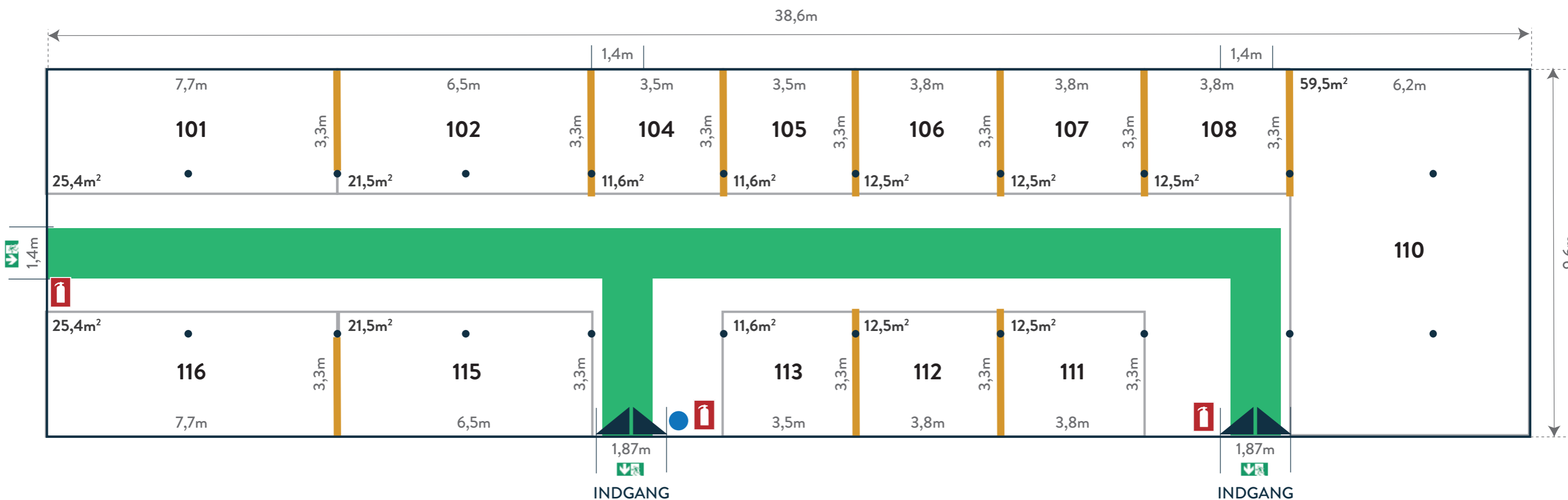

- Opsatte trævægge
- Flugtsareal eller flugtsvejspassage, min 1,3m
- Ophængningssted for beredskabsplan
- Kulsyreslukker
- Flugtsarmatur

Pax	149
Bygning	370,1 m²
Stande	237 m²

STANDBYGNING 2 - DEN STORE LADE

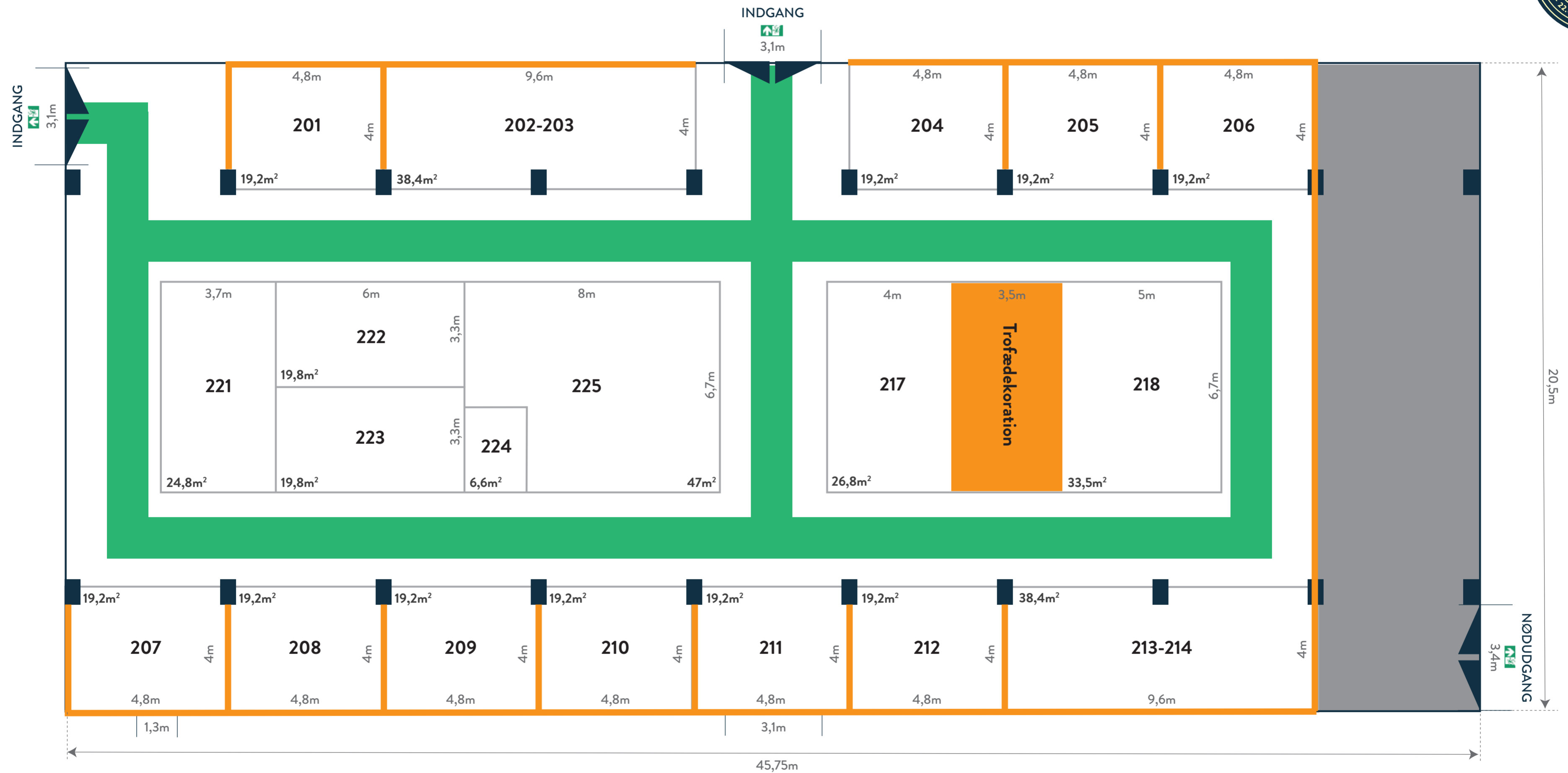





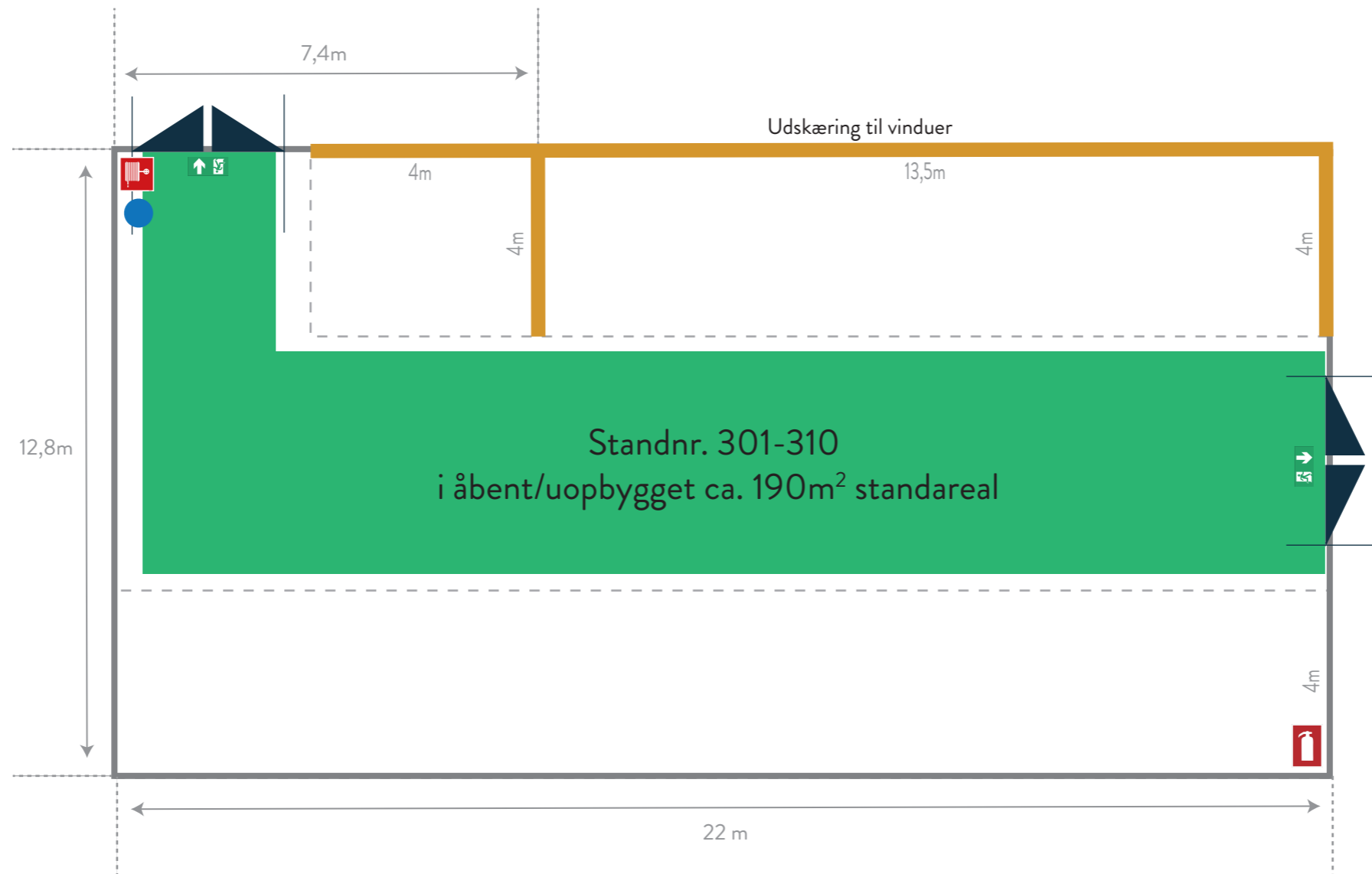

- Opsatte trævægge
- Flugtvejsareal eller flugtvejspassage, min. 1,3m
- Ophængningssted for beredskabsplan
- ⬇ Flugtvejsarmatur

Pax	350
Bygning	813,4 m ²
Stande, alm	268,8 m ²
Stande, rå	178,3 m ²

STANDBYGNING 3 - DEN LILLE LADE



-  Opsatte trævægge
-  Flugtvejsareal eller flugtvejspassage
-  Ophængningssted for beredskabsplan
-  Kulsyreslukker
-  Slangevinde
-  Flugtvejsarmatur

Pax	?
Bygning	282 m ²
Stande, alm	? m ²
Stande, rå	190 m ²

STANDBYGNING 4 - DEN GAMLE KOSTALD

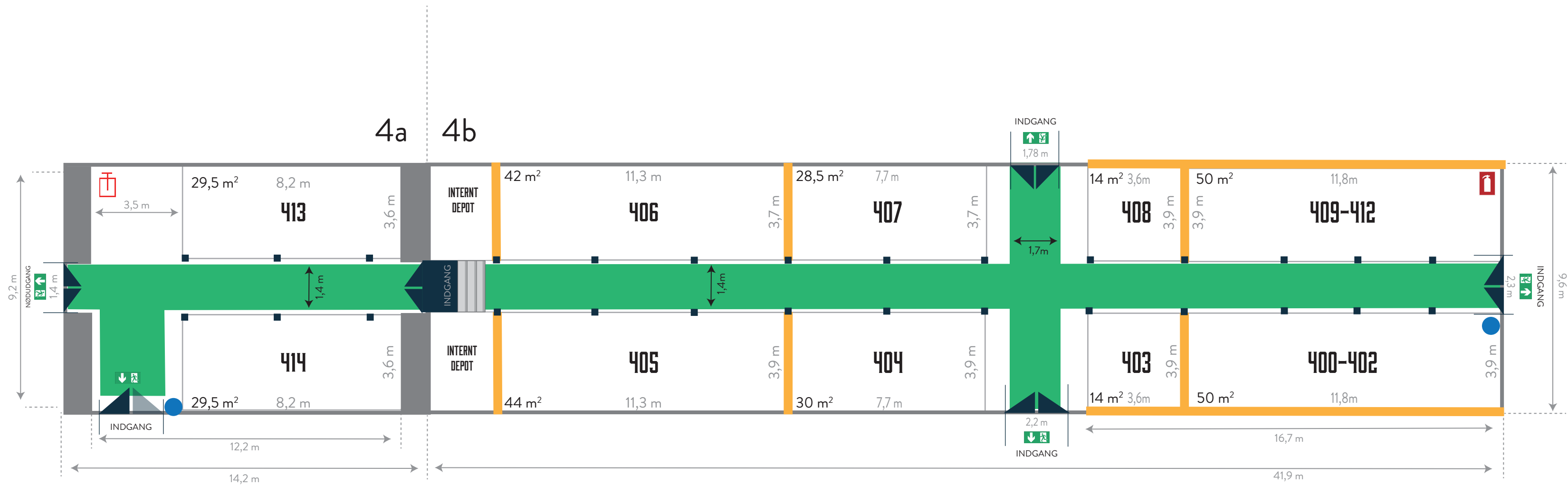

- Opsatte trævægge
- Flugtvejsareal eller flugtvejspassage
- Ophængningssted for beredskabsplan
- Kulsyreslukker
- Håndsprøjtebatteri
- Flugtvejsarmatur

	4a	4b
Pax	149	
Bygning	112,2 m ²	402 m ²
Stande, alm	59 m ²	272,5 m ²

STANDBYGNING 5 - DEN NYE LADE

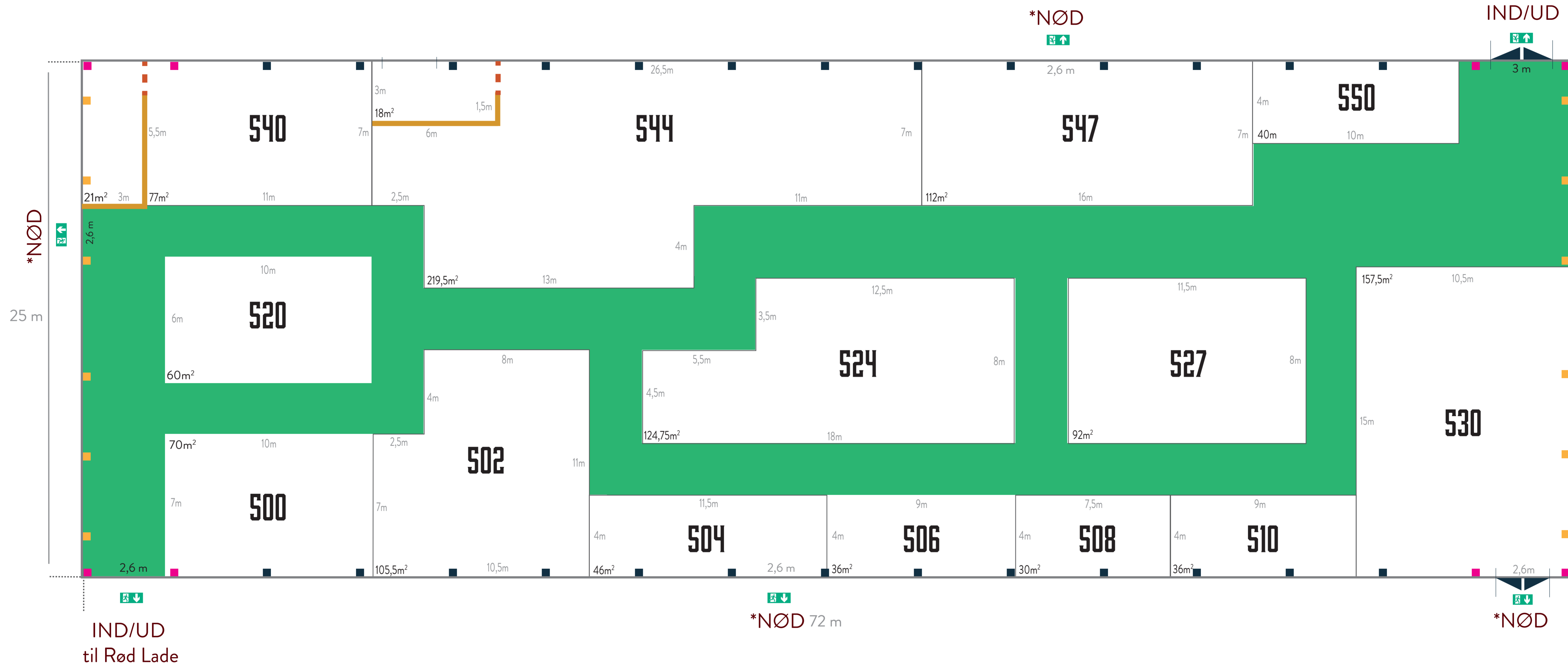

- Forhæng, Bredde: 1,5m
- Eksisterende træbeklædning
- Opsatte trævægge
- Opsætning af trævægge muligt
- Flugtvejsareal eller flugtvejspassage
- Ophængningssted for beredskabsplan
- Kulsyreslukker
- Flugtvejsarmatur

Pax	549
Bygning	1800 m²
Stande	1245,25 m²

STANDBYGNING 6 - DEN RØDE LADE

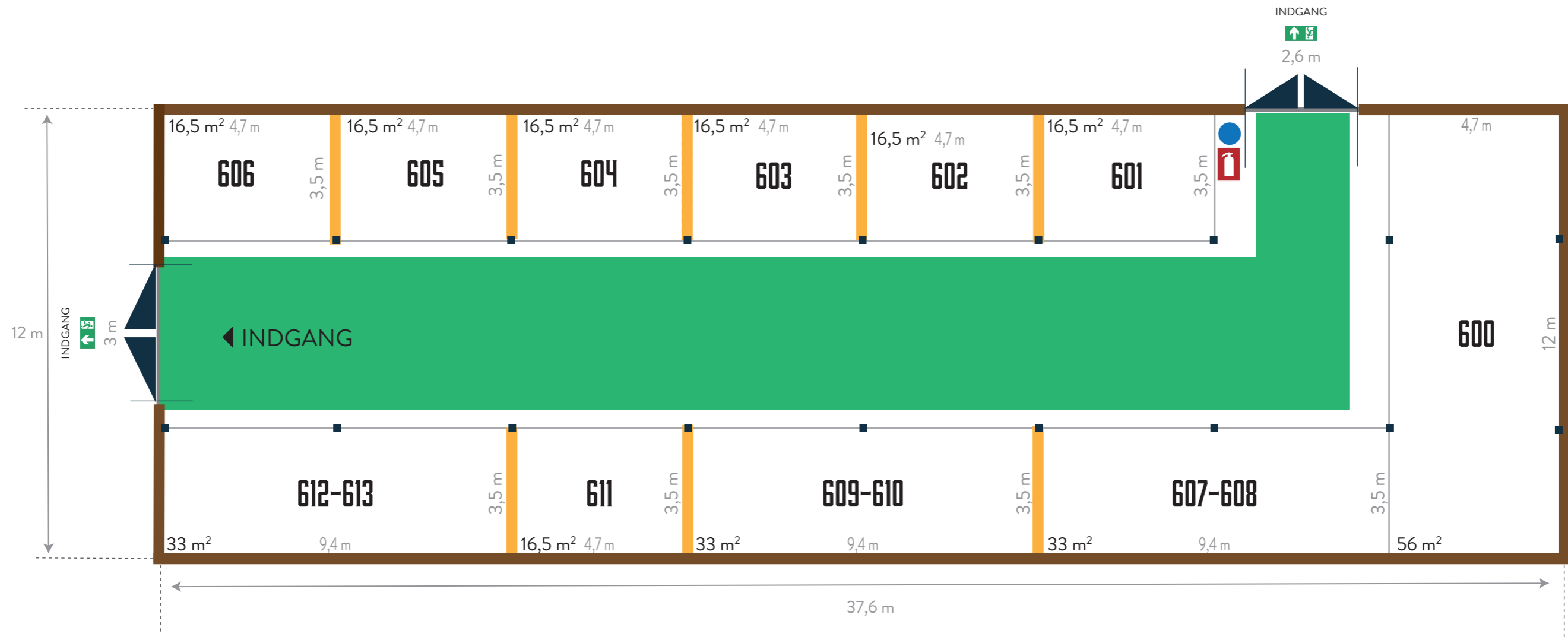

- Eksisterende træbeklædning
- Opsatte trævægge
- Opsætning af trævægge muligt
- Flugtvejsareal eller flugtvejspassage
- Ophængningssted for beredskabsplan
- Kulsyreslukker
- Flugtvejsarmatur

Pax	149
Bygning	451 m ²
Stande	270,5 m ²

TELTE



Ø ØSTFLØJEN 90 m²

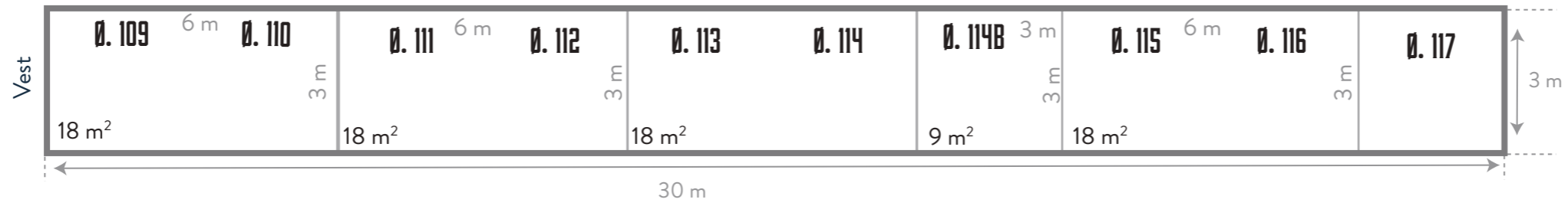

P1 PARKEN 1 216m²

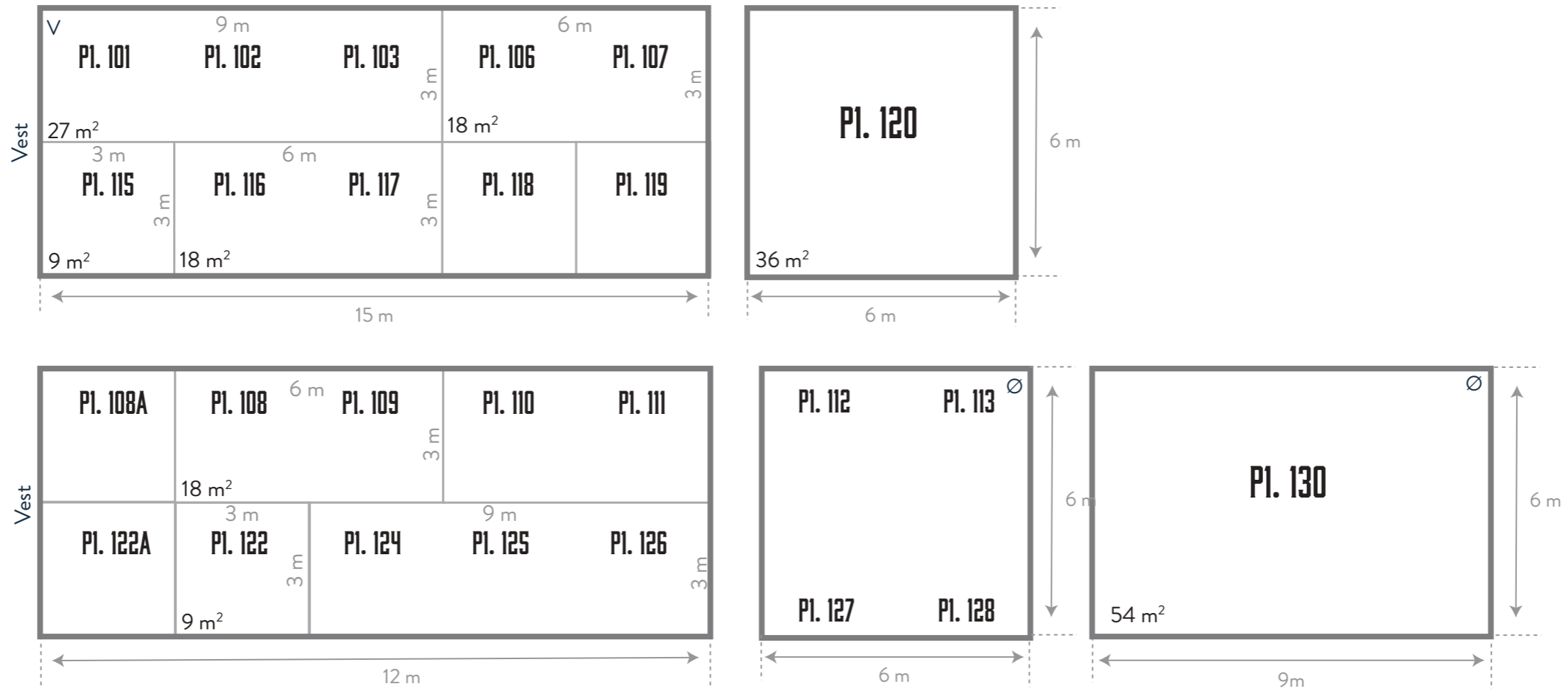



TELTE

K KRONDYRHEGNET 108 m²

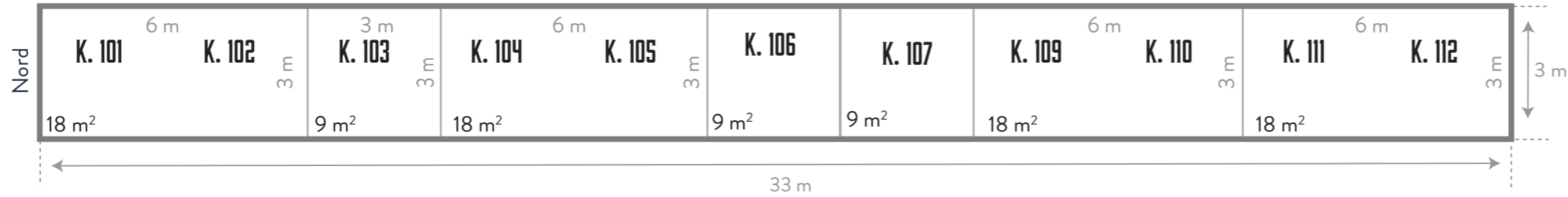

D DAMMENE 243 m²

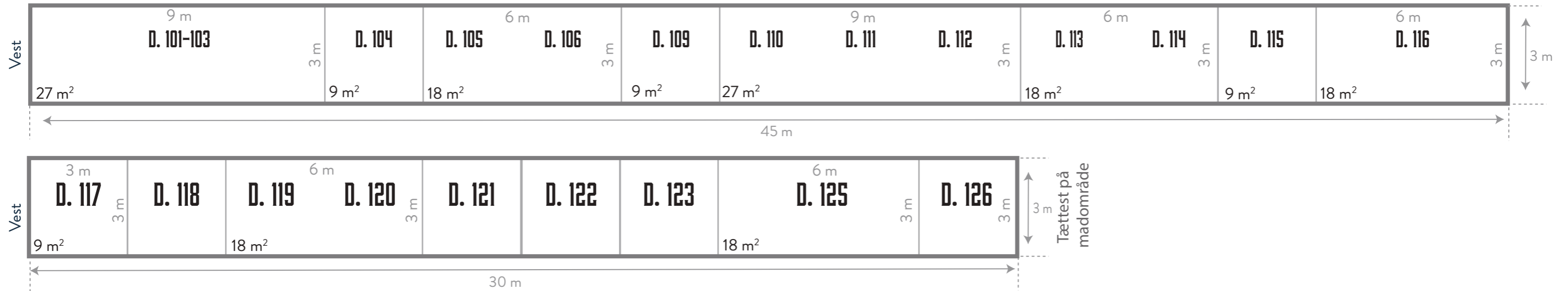

J KNIVMAGERE 63 m² SE DELTAGERE I LISTE VED SIDEN AF

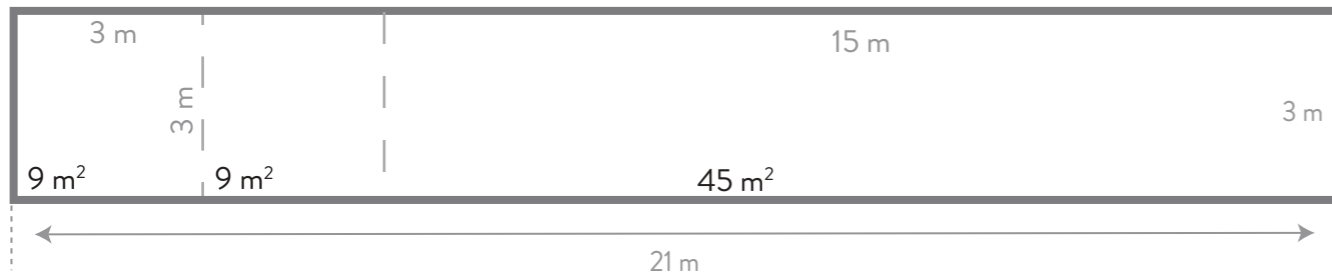

J KNIVMAGERE



F FODERHUSET 36 m²

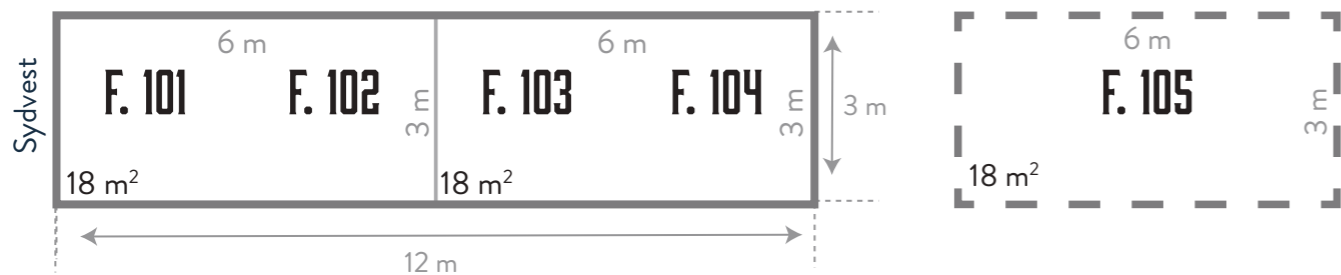

TELTE



H HUNDEOMRÅDE V. TRIBUNEN 144 m²

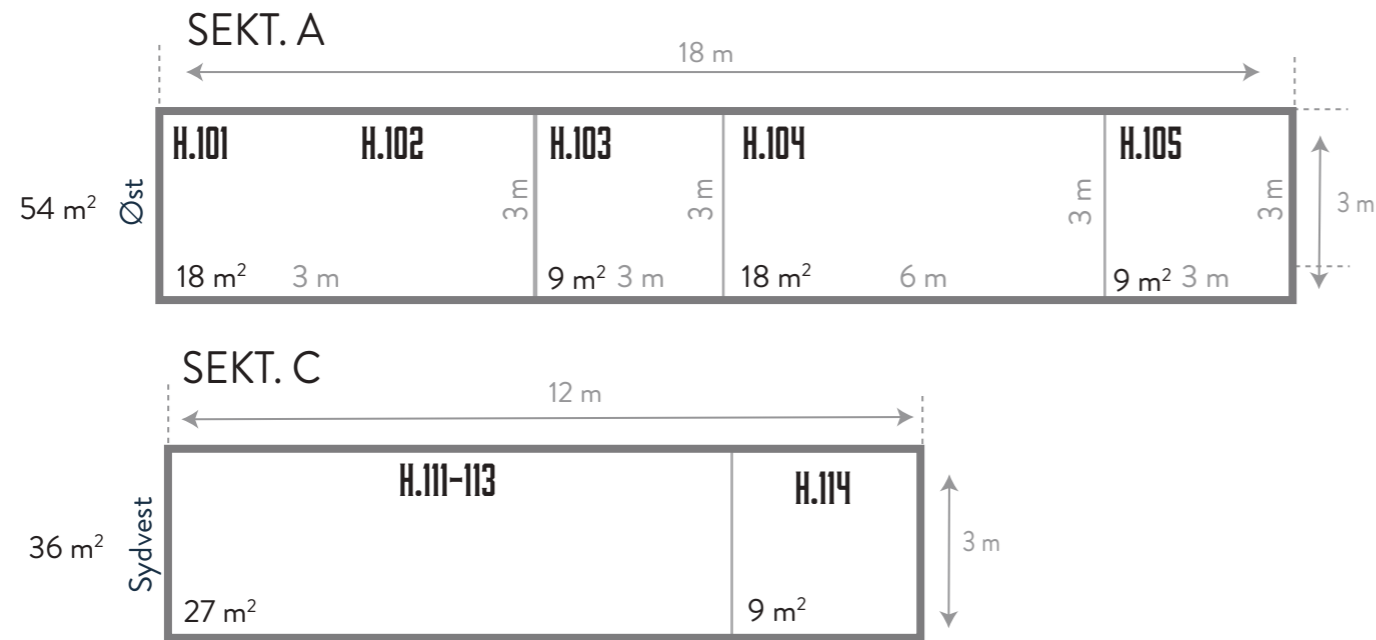

TELTE



● PLÆNE / PARKEN

● DEMOMARK/4X4 TESTKØRSEL

● SKYDEBANE - HAGL

● SKYDEBANE - RIFFEL/LUFTGEVÆR

● JÆGERFORBUND / BLIV NATURLIGVS / ALLÉEN

● CLINIC BANER

● MADBODER

● OUTDOOR

● GÅRDSPLADS VED BYGNING 6

● VED SKYDEBANERNE